

SSL UF8

User Guide

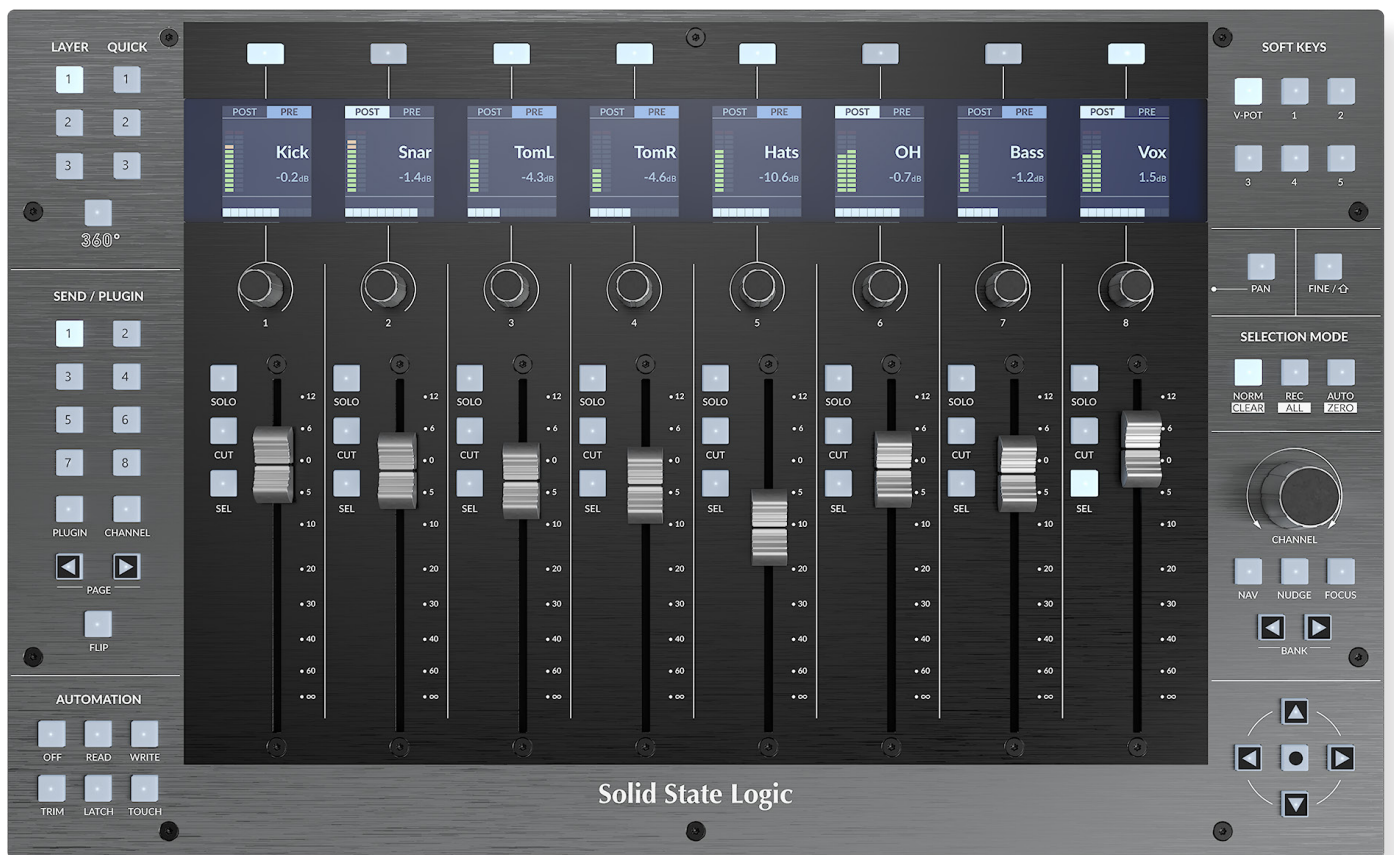

Solid State Logic

O X F O R D • E N G L A N D

Visit SSL at:
www.solidstatelogic.com

© Solid State Logic

All rights reserved under International and Pan-American Copyright Conventions.

SSL® and Solid State Logic® are registered trademarks of Solid State Logic.

SSL UF8™ is a trademark of Solid State Logic.

All other product names and trademarks are the property of their respective owners and are hereby acknowledged.

Pro Tools® is a registered trademark of Avid®.

Live™ is a trademark of Ableton® AG.

Logic Pro® and Logic® are registered trademarks of Apple® Inc.

Studio One® is a registered trademark of Presonus® Audio Electronics Inc.

Cubase™ and Nuendo™ are trademarks of Steinberg® Media Technologies GmbH.

Mackie® is a registered trademark of LOUD Technologies® Inc.

BOSS® is a registered trademark of Roland® Corporation.

No part of this publication may be reproduced in any form or by any means, whether mechanical or electronic, without the written permission of Solid State Logic, Begbroke, OX5 1RU, England.

As research and development is a continual process, Solid State Logic reserves the right to change the features and specifications described herein without notice or obligation.

Solid State Logic cannot be held responsible for any loss or damage arising directly or indirectly from any error or omission in this manual.

PLEASE READ ALL INSTRUCTIONS, PAY SPECIAL HEED TO SAFETY WARNINGS.

E&OE

Revision 1.6 - July 2021 | Updated to include Plug-in Mixer Support in v1.2 SSL 360° Software

Table of Contents

Overview	5
What is SSL UF8?	5
Features	5
Using This User Guide Effectively	5
Safety Notices	5
Get-Started	6
Unpacking	6
Fitting The Stands (Optional)	6
Rack Mount Kit	7
UF8 Physical Specification	7
Connecting Your UF8 Hardware	8
Downloading SSL 360° Software	9
Installing SSL 360° Software	9
System Requirements	9
Keyboard Identify (Mac Only)	10
Registering Your UF8	11
UF8 YouTube Tutorials	11
UF8 Hardware Layout	12
Front Panel	12
Connector Panel	15
SSL 360° Software Overview	16
Overview & Home Page	16
UF8 Page	18
DAW Communication	21
SSL V-MIDI Ports	21
DAW Protocols	21
Pro Tools with UF8 - Tutorial	22
SSL 360° Setup	22
Pro Tools Setup	22
LCD Layout	23
Tutorial	24
Logic with UF8 - Tutorial	33
SSL 360° Setup	33
Logic Setup	33
LCD Layout	35
Tutorial	36
Cubase/Nuendo with UF8 - Tutorial	44
SSL 360° Setup	44
Cubase Setup	44
LCD Layout	46
Tutorial	47
Ableton Live with UF8 - Tutorial	56
SSL 360° Setup	56
Live Setup	56
LCD Layout	57

Tutorial	58
Studio One with UF8 - Tutorial	64
SSL 360° Setup	64
Studio One Setup	64
LCD Layout	66
Tutorial	67
Plug-in Mixer - Tutorial	78
SSL 360° Setup	78
Plug-in Mixer Setup	78
Tutorial	79
Accessing Channel Strip Mode, Bus Compressor Mode, Metering	79
LCD Layout - Channel Strip Mode	80
LCD Layout - Bus Compressor Mode	81
UF8 LCD Messages	86
SSL 360° Software Messages	87
SSL Support - FAQs, Ask a Question and Compatibility	88
Safety Notices	89

Overview

What is SSL UF8?

SSL UF8 is a scalable hardware control surface offering the essential DAW control you need, with room to add USB keyboard shortcut sequences to suit your own workflow. UF8 features 8 high-quality, motorised touch-sensitive faders accompanied by 8 endless rotary encoders and 8 high-quality colour LCD TFTs for clear visual feedback at all times. A large multi-purpose master encoder allows navigation of DAW sessions, track scrolling and mouse wheel emulation to give hands-on control of plug-ins. Signature SSL workflow and ergonomics developed from a 40+ year legacy in production innovation have never been more accessible.

Features

- 8 x 100 mm high quality, touch-sensitive motorised faders.
- 8 x rotary endless rotary encoders with push.
- 8 x high-resolution colour displays.
- Backlit RGB soft-feel rubber buttons.
- All metal enclosure, finished with a brushed anodised top plate.
- Expandable - Connect up to 4 UF8s to create a 32-channel control surface.
- Works out of the box with the following major DAWs: Pro Tools, Logic, Cubase, Nuendo, Studio One, Ableton Live.
- Up to 3 different DAWs can be connected simultaneously and switched between using the Layer keys.
- DAW communication via HUI for Pro Tools. SSL software provides further workflow enhancements with the addition of features such as Channel and Plug-in Modes.
- DAW communication via MCP/MCU for Logic, Cubase, Nuendo, Studio One and Ableton Live.
- A large multi-purpose notched encoder allows for DAW timeline navigation, track banking and mouse wheel emulation for even more hands-on control.
- Customisable user keys ready to assign your favourite DAW commands or keyboard shortcuts.
- 2 x assignable foot-switch inputs.
- Included stands allow for 6 different elevation angles. Or, use without stands.
- Optional 19" 6U rackmount kit available.
- Connects to your computer via hi-speed USB – no need to deal with computer networks or ethernet cables.
- Powered by the SSL 360° Software application.

Using This User Guide Effectively

This User Guide will take you through the process of getting up-and-running with your UF8 control surface. The **Get-Started** section will guide you through unboxing, attaching the stands and installing SSL 360°, the intelligent software command centre that drives UF8. This section also provides information on registering your UF8 surface, which will allow you access to any additional software that your UF8 purchase provides.

The **Hardware Layout** section provides an overview of the UF8 surface, to help familiarise yourself with the names of controls and how they are laid out. **SSL 360° Software Overview** provides detail on the SSL 360° software and what functionality you can expect from it. **DAW Communication** provides the essential technical information on how UF8 (via SSL 360°) communicates with your DAW and last but not least, the **DAW Tutorials** sections provide you with the configuration steps you need to take inside your DAW to connect UF8, whilst also guiding you through how UF8 interacts with your chosen DAW.

Safety Notices

Please read the **Important Safety Notices** at the end of this User Guide before use.

Get-Started

Unpacking

The unit has been carefully packed and inside the box you will find the following items in addition to your UF8 control surface:

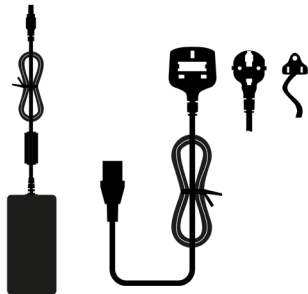

12 volts, 5 A Power Supply and IEC Cable

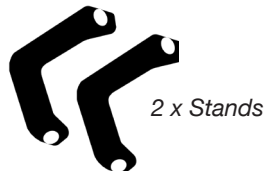

2 x Stands



1 x Hex Key
4 x Screws

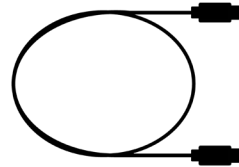

1.5 m C to C USB Cable

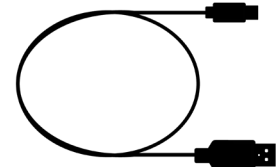

1.5 m C to A USB Cable

Fitting The Stands (Optional)

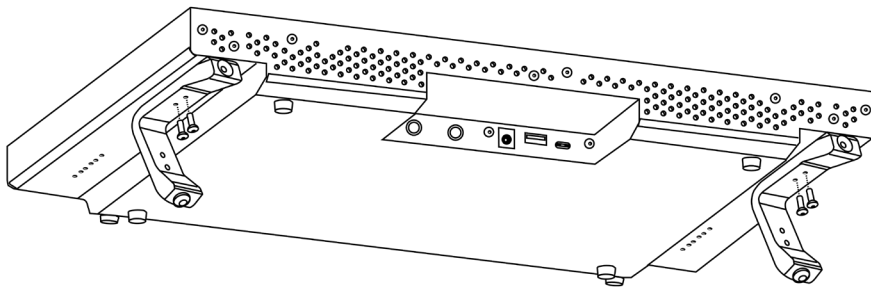

UF8 has been designed to be used with or without the included screw-in stands, depending on your preference. Attaching the included screw-in stands has the added benefit of angling the unit towards you. Three different fixing positions (the holes are arranged in pairs) allow you to choose an angle that is best for your setup. Use 2 screws per stand. **Please be careful not to over-tighten to avoid stripping the screw threads.** For those with a torque measuring device, tighten to 0.5 Nm.

Additional Elevation Angles

If you need a steeper angle of elevation, you can rotate the stands and fix them to the chassis using the shorter side. This gives you three additional angle options to choose from.

1. Unscrew the rubber feet and move to the other end

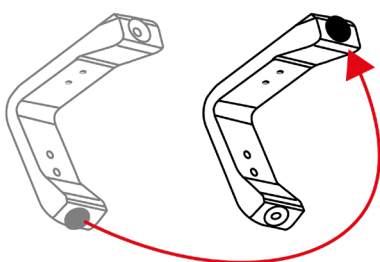

2. Rotate the stands so that the short side fixes to the chassis

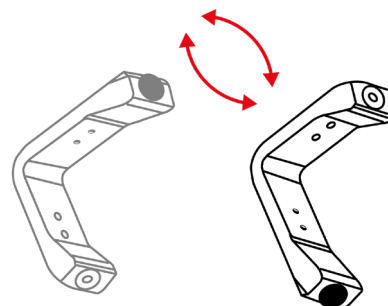

Rack Mount Kit

A 19" in rack mount kit is available for purchase separately should you wish to rack mount your UF8. When rack-mounted, UF8 occupies 6U of space.

Attaching the rack mount ears

The kit contains a set of metal racking ears and 12 screws, which should be secured to the chassis using the lower 3 screw holes at the top and bottom of each side (6 in total per side), as pictured below. **Please be careful not to over-tighten to avoid stripping the screw threads.**

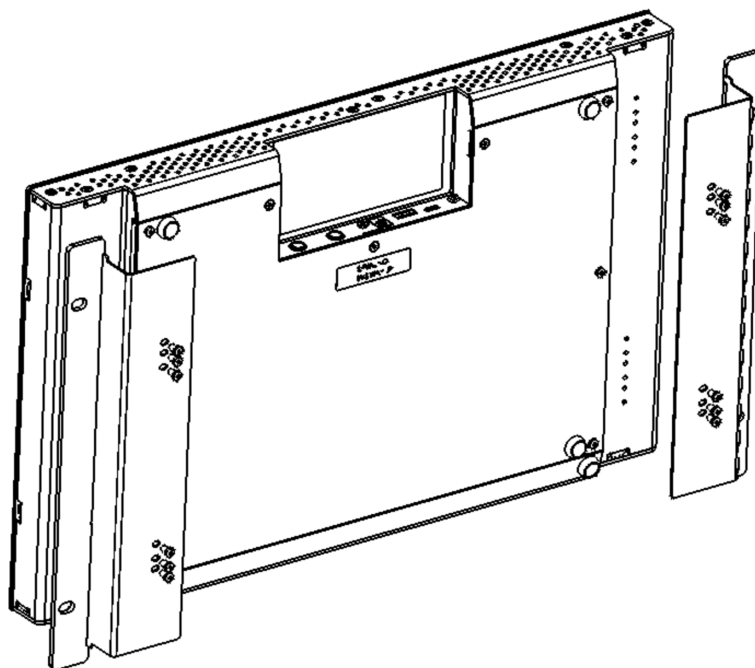

UF8 Physical Specification

Dimensions

17" x 10.5" x 2.4" / 431 x 266 x 62.7 mm (Width x Depth X Height)

Weight

Unboxed - 2.9 kg / 6.4 lbs

Boxed - 5.0 kg / 11.02 lbs

Connecting Your UF8 Hardware

1. Connect the included power supply to the **DC** socket on the connector panel.
2. Connect one of the included USB cables from your computer to the **USB** socket.

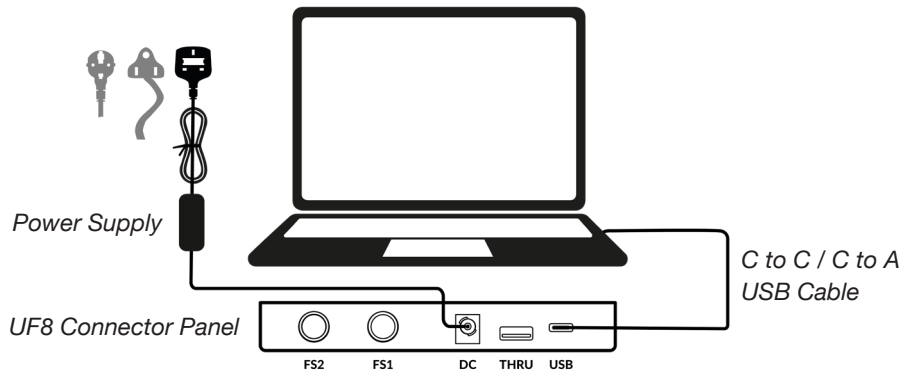

USB Cables

Please use one of the provided USB cables ('C' to 'C' or 'C' to 'A') to connect UF8 to your computer. The type of USB port you have available on your computer will determine which of the two included cables you should use. Newer computers may have 'C' ports, whereas older computers may have 'A'. Please ensure that you are connecting to the port labelled **USB** on UF8, which is a 'C' type connection.

Connecting Multiple UF8s

If you are using more than one UF8, you can use the **THRU** port (USB 'A' type) to link communication across multiple units. This means that only one USB port is required at your computer.

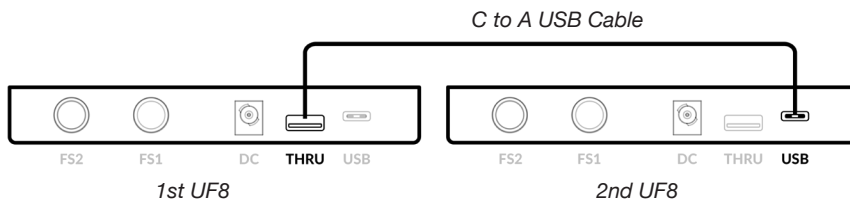

Theoretically, you can chain 4 UF8s together in the way described above. However, by doing so you may exceed the number of hub tiers permitted by your PC/Mac computer. As such, you may need to connect your 3rd/4th UF8 unit directly to another USB port on your computer. The same applies regarding the use of USB hubs; the 3rd/4th UF8(s) may need to be plugged directly into a different USB port on your computer.

Tip: The **THRU** port can also be used to plug in USB dongles that are often required for DAW software.

How Many UF8s Can I Use?

A maximum of 4 UF8s can be used to create a 32-channel control surface.

Downloading SSL 360° Software

UF8 requires the SSL 360° software to be installed on your computer in order to function. SSL 360° is the brains behind your UF8 control surface. Once you have connected your UF8 hardware to your computer as described on the previous page, please download SSL 360° from the SSL website.



1. Go to www.solidstatelogic.com/support/downloads
2. Select **UF8** from Products drop-down list.
3. Download the SSL 360° software for your Mac or PC.

Installing SSL 360° Software

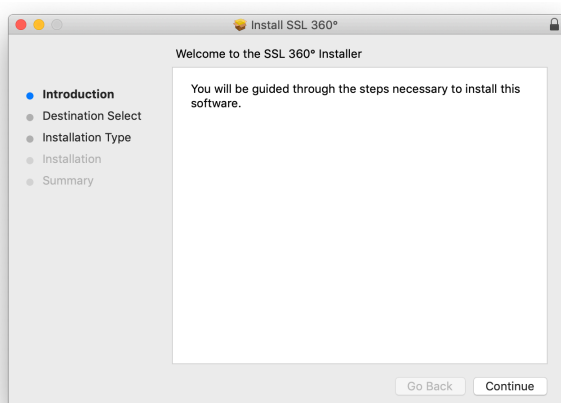

Mac

1. Locate the downloaded SSL 360°.dmg on your computer.
2. Double-click to open the .dmg.
3. Double-click to run the SSL 360°.pkg.
4. Proceed with the installation, following the on-screen instructions.

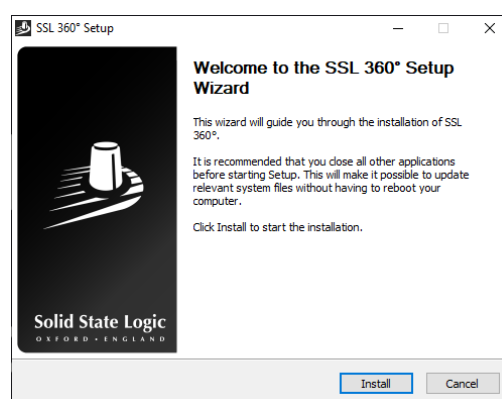

Windows

1. Locate the downloaded SSL 360°.exe on your computer.
2. Double-click to run the SSL 360°.exe.
3. Proceed with the installation, following the on-screen instructions.

System Requirements

Computer operating systems and hardware are constantly changing. Please search for '*UF8 Compatibility*' in our online FAQs to check if your system is currently supported.

Keyboard Identify (Mac Only)

One of the special features of UF8 is its ability to trigger keyboard command sequences of your favourite DAW shortcuts. These are assigned using the SSL 360° software and this is covered later in this User Guide.

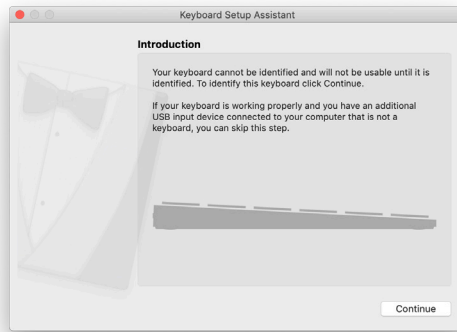

When you first plug in your UF8, Mac OS will present the above 'Keyboard Setup Assistant' window because Mac OS wants you to identify which region (Europe, America or Japan) this, as yet unidentified, keyboard is from. **If you connected your UF8 to your computer before installing SSL 360° software, you need to close this setup assistant because SSL 360° needs to be installed on your computer in order to continue through this setup process.** To make the Keyboard Setup Assistant appear again once SSL 360° is installed, do the following: Open up Mac's 'System Preferences' > Go to 'Keyboard' > Click 'Change Keyboard Type' (please note, your UF8 must be connected to your computer via a USB cable) and click 'Continue'.

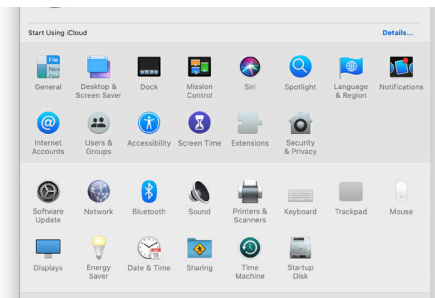

STEP 1: Go to System Preferences and click 'Keyboard'.

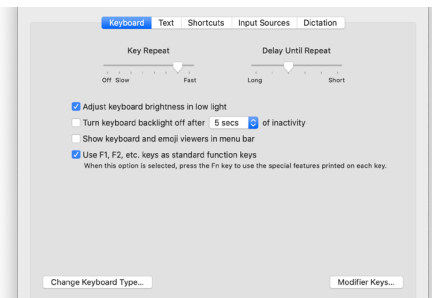

STEP 2: Click 'Change Keyboard Type'

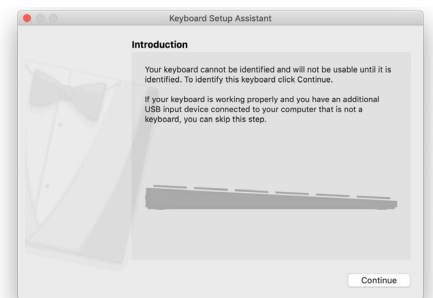

STEP 3: Click 'Continue'.

- When presented with 'Identifying Your Keyboard' and you are being asked to 'Press the key immediately to the right of the Shift Key', at this point, press and hold the **360°** key on UF8 for 3 seconds until the key lights orange.
- This will move you through to the final step of the process, where you can choose the appropriate option (Europe, America or Japan) for your region and then click 'Done'.



STEP 4: When presented with the message 'Press the key immediately to the right of the Shift Key', press and hold the 360° key on UF8 for 3 seconds until it lights orange.



STEP 5: Select your region and click 'Done'.

Registering Your UF8

Register your UF8 for the best possible experience and to gain access to any additional software in your SSL user account.

<http://www.solidstatelogic.com/get-started>



To register your product, head to www.solidstatelogic.com/get-started and follow the on-screen instructions. During the registration process, you'll need to input the serial number of your unit. **This can be found on the label on the base of your unit.**

XX-XXXXXX-XXXXXXXXXXXX
SERIAL NUMBER

Please note: Xs are used to demonstrate the format of the serial number. The actual serial number will contain a mixture of letters and numbers.

Once you have completed registration and logged-in, all of your software content will be available in your user area. You can return to this area at any time by logging back into your SSL account at www.solidstatelogic.com/login should you wish to download the software another time.

UF8 YouTube Tutorials

The SSL YouTube channel hosts in-depth tutorials on how to setup and use UF8 with your DAW.



UF8 Hardware Layout

Front Panel

This section will help familiarise yourself with the front panel controls of the UF8 surface. It is intended to be an overview, rather than a comprehensive explanation of each function or mode. For more detail on the integration of features with each DAW, please refer to the DAW Tutorials sections of this User Guide.

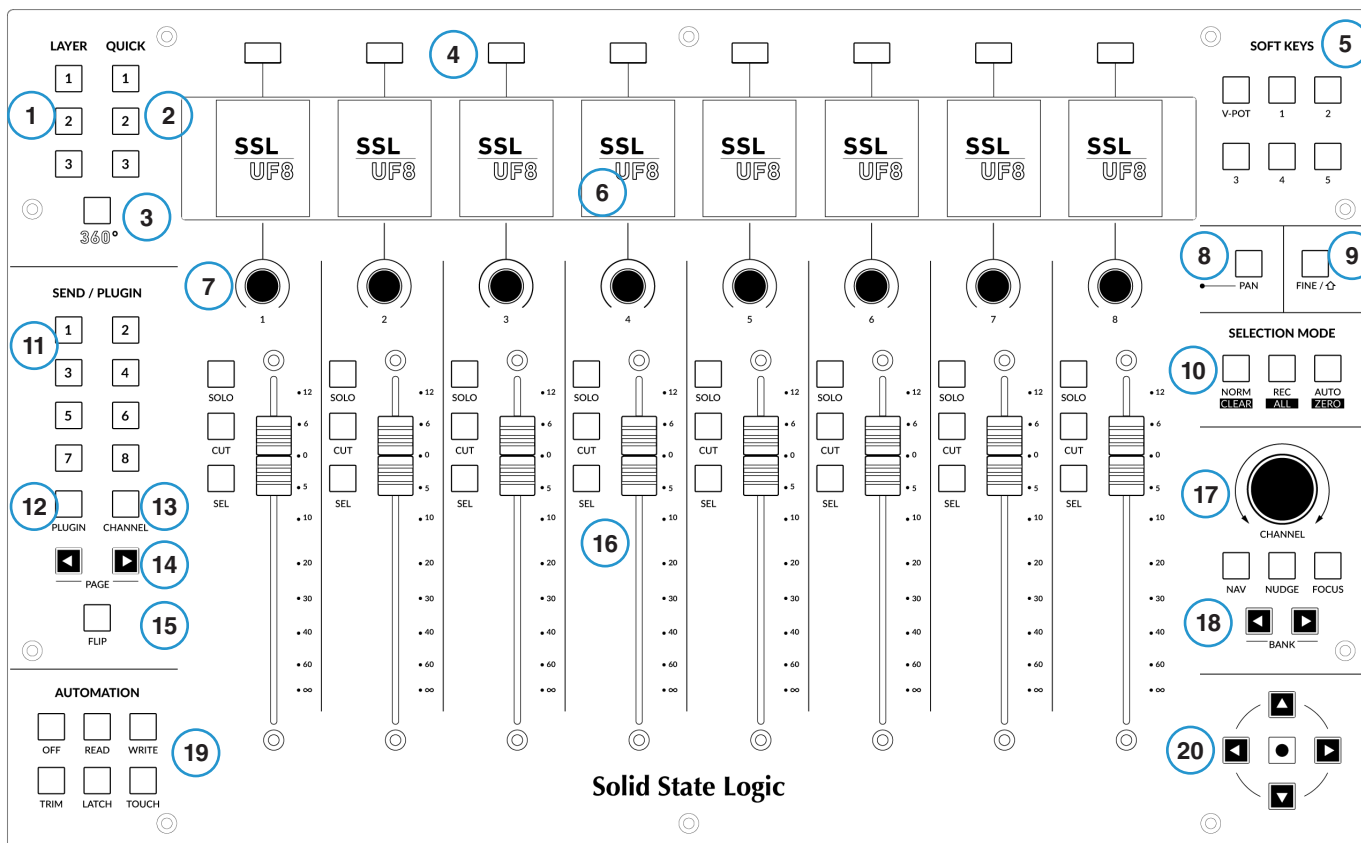

1 - LAYER Keys 1-3

Control of up to 3 DAWs can be configured and switched between using these keys on the UF8 surface.

2 - QUICK Keys 1-3

User-assignable keys that can be mapped to any of the available HUI/MCU commands in SSL 360°, or alternatively any keyboard shortcut sequence of your choosing.

3 - 360° Key

Opens/minimises the SSL 360° software on your computer screen.

4 - 8 x Soft Keys

A line of 8 soft keys allow access to various **V-POT** parameters or, up to 40 user-assignable keys per UF8. The label for the function of each key is displayed in the top section of the LCD below.

5- SOFT KEYS

Determines the operating mode of the 8 top-row soft keys. Keys labelled **1-5** provide access to User Banks 1-5. **V-POT** puts the top-row soft keys into **V-POT** mode. See DAW tutorial sections for more information.

6 - 8 x colour LCD TFTs provide visual feedback including metering, track names, **V-POT** readouts, track record-arm states and more.

7 - 8 x **V-POTS**

"V-Pot" is short for "virtual pot" and these are used to control various DAW parameters including Pan position, Send levels and Plug-in parameters.

8 - **PAN** Key

Assigns the DAW's Pan controls to the V-Pots.

9- **FINE / SHIFT** Key

For most DAWs, this key either engages a **FINE** mode of control for the parameter currently assigned to the V-Pots, or it acts as a Shift Key. The function of this key varies between DAWs.

10 - **SELECTION MODE** Keys

Determines the behaviour of the **SEL** (Select) keys. These Selection Mode keys also perform secondary functions in Pro Tools and Logic when pressed and held, and are used in combination with the **SOLO**, **CUT** and **SEL** keys.

11 - **SEND / PLUGIN 1-8** Keys

The behaviour of these keys varies for each DAW. Please see the relevant DAW Tutorial section for more information.

12 - **PLUGIN** Key

The behaviour of the **PLUGIN** key varies for each DAW. Please see the relevant DAW Tutorial section for more information.

13 - **CHANNEL** Key

The behaviour of the **CHANNEL** key varies for each DAW. Please see the relevant DAW Tutorial section for more information.

14 - **PAGE < and >** Keys

The behaviour of the **PAGE < >** keys varies for each DAW. Please see the relevant DAW Tutorial section for more information.

15 - **FLIP** Key

FLIP is used to assign the current V-Pot parameter to the fader and can be used for tasks such as riding send levels.

16 - **SOLO, CUT, SEL** and 100 mm Motorised Faders

The most common controls found in all DAWs. Please note that the function of the **SEL** keys depends on the currently active **SELECTION MODE**.

17 - Large Notched **CHANNEL** Encoder

The large encoder can function in several different modes:

- Standard Mode - Push the encoder itself to return to **CHANNEL** mode. Moving the encoder will bank DAW tracks one at a time.
- **NAV** Mode - 'Nav' is short for Navigation. In this mode, the encoder allows you to move the playhead cursor along your DAW timeline.
- **NUDGE** Mode - This mode is only supported by Pro Tools. It allows you to use the encoder to move selected audio regions by the currently set Nudge value.
- **FOCUS** Mode - This mode turns the operation of the large encoder into a mouse wheel scroll emulation and is great for controlling plug-ins. Simply hover your computer mouse over the desired control and turn the encoder. The sensitivity of this mode will be determined by your computer's mouse scroll sensitivity settings.

18 - **BANK < >** Keys

These keys allow you to bank through the tracks in your DAW, bringing them onto your UF8 control surface(s). Banking works in groups of 8/16/24/32, depending on the DAW and the number of UF8s you have connected.

19 - **AUTOMATION** Keys

These keys provide access to the various automation modes available in each DAW. Please note that when working in Pro Tools, the **SELECTION MODE** must be in **AUTO** before these keys become active.

20 - Navigation Arrows and Mode Key

These keys perform various functions including DAW timeline zooming and important tasks such as selection of plug-in slots (Logic only). Please refer to the DAW Tutorials section for more information.

"Nice to meet you, where you been? I could show you incredible things." - Taylor Swift, Blank Space.

Connector Panel

The recessed section hosts UF8's connectors.

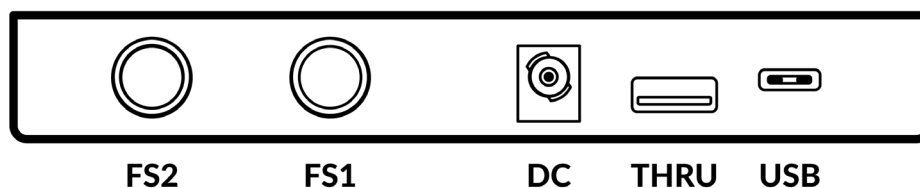

USB - 'C' Type Connector

Connect one of the included USB cables from your computer to the **USB** port on UF8. This handles all of the communication between your DAW and UF8, via the SSL 360° software application.

THRU - 'A' Type Connector

The **THRU** connector can be used to chain multiple UF8s together, without needing to plug each unit into your computer or a hub individually. It can also be used to plug in USB dongles.

DC Connector

Use the included DC Power Supply to provide power for your UF8.

FS1 & FS2 - 1/4" Jack Connectors

These allow for the connection of foot-switches, which can be used to trigger DAW commands or user-assigned keyboard shortcut sequences.

UF8 has been tested with popular foot-switches such as the BOSS FS-6 (other brands are available), whose foot-switch behaviour (or polarity as it is often referred to), is a 'normally closed' switch. In some cases, these foot-switches offer the ability to change the polarity.

Please use a foot-switch designed for '**normally closed**' operation and also, to ensure full compatibility use a **momentary** action foot-switch, or choose a foot-switch that can be set to momentary. This will ensure correct operation with assigned DAW commands.

SSL 360° Software Overview

Overview & Home Page

SSL 360° software is not only the 'brains' behind the UF8 control surface, it is also the command centre from which new versions of software and firmware can be downloaded for your 360° compatible device.

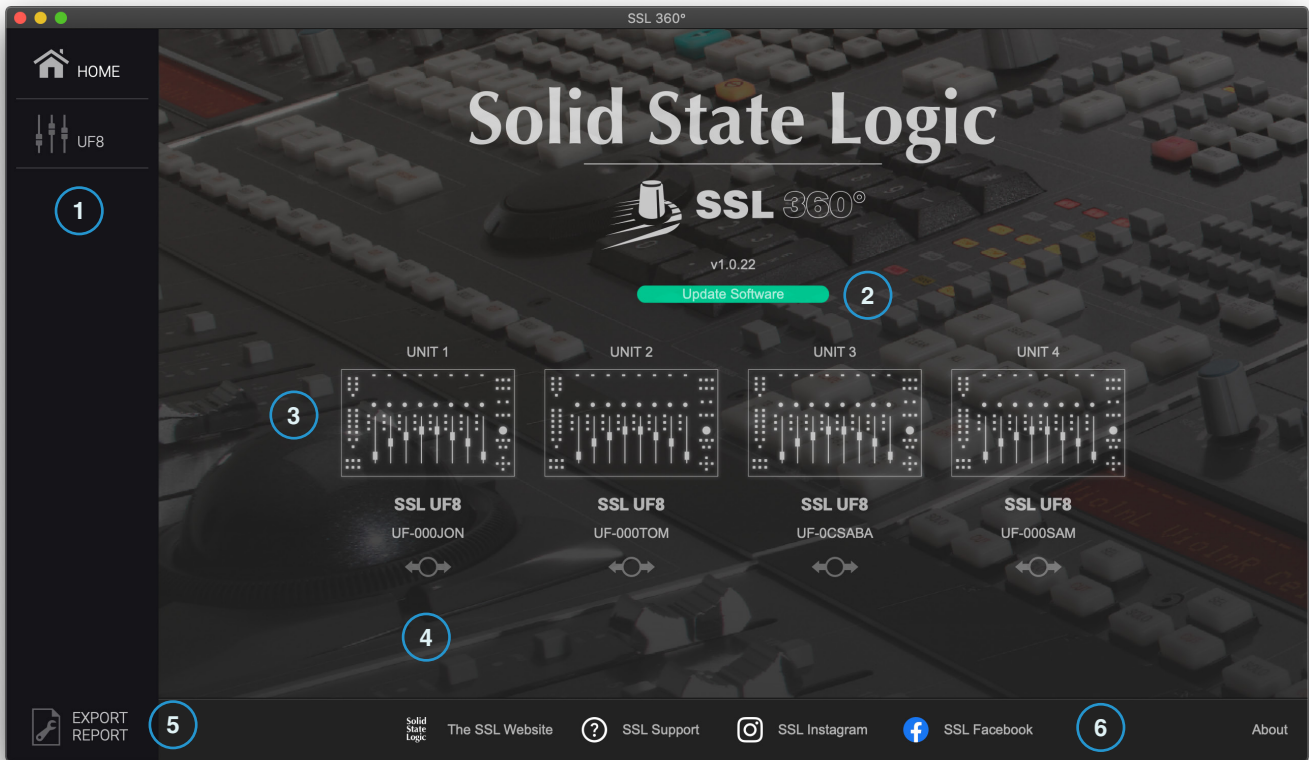

The **HOME** screen:

1 - Menu Toolbar

This toolbar allows you to navigate through the various pages of SSL 360°.

2 - Software Version Number & **Update Software** Button

This area displays the version number of SSL 360° that is running on your computer. When software updates become available, the **Update Software** button (pictured above) will appear. Click this to download and update your software.

3 - Connected Units

This area shows any UF8s that are connected to your computer, along with their respective serial numbers. **Please allow 10-15 seconds for units to be discovered once they are plugged in.**

Identify & Drag To Re-Order

Usefully, there is a built-in feature that allows you to identify each UF8 control surface and re-order if appropriate. Clicking your mouse down on the image of each connected UF8 will temporarily override that unit's LCDs to display the SSL UF8 logo. If your UF8s are not arranged in the order you want, you can simply drag and drop on-screen to re-arrange.

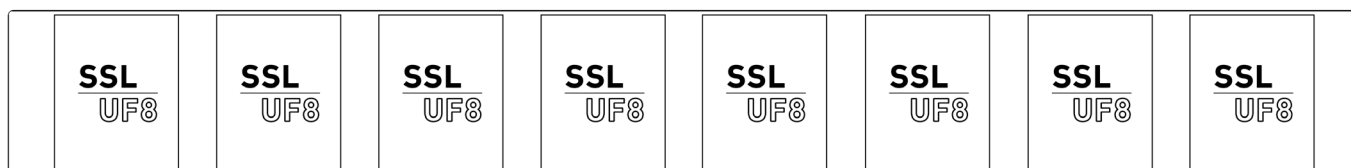

Clicking the mouse down on a connected UF8 image will cause all the displays on that particular UF8 to momentarily show the SSL UF8 logo, helping you identify each UF8 control surface.

4 - Firmware Updates Area

If a firmware update becomes available for your UF8 unit, then an **Update Firmware** button will appear below each unit. Click on the button to start the firmware update process, being sure to not disconnect the power or USB cable(s) whilst it is in progress.

5 - EXPORT REPORT

Should you encounter any issues with your UF8 or SSL 360° software, you may be asked by a support agent to use the **EXPORT REPORT** feature. This feature generates a text file containing the essential information about your computer system and UF8(s), alongside technical log files relating to SSL 360° activity, which may help to diagnose any issues. When you click **EXPORT REPORT**, you'll be asked to choose a destination on your computer to export the generated .zip file to, which you can then forward onto the support agent.

6 - SSL Socials

The bar at the bottom has quick links to the SSL website, Support section and SSL Socials.

This space is intentionally almost entirely blank... it's a tradition.

UF8 Page

The UF8 page can be selected from the menu toolbar on the left-hand side and is where you configure UF8 to work with your DAW(s). It is also the place where you can customise any of the user-assignable keys. Customised DAW profiles can then be saved and loaded as .xml files should you need to work on another computer with SSL 360° installed.

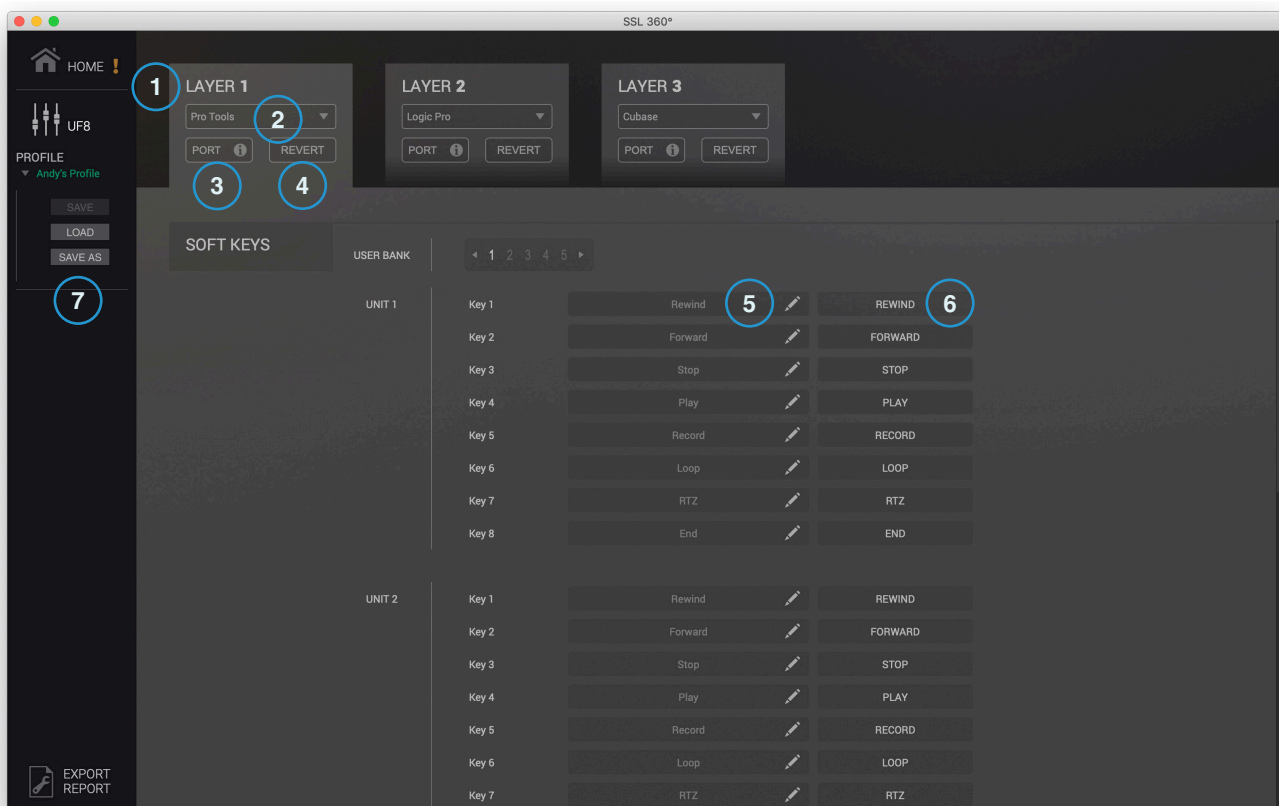

1 - LAYER Tabs

UF8 can be configured for 3 different DAWs simultaneously, with each DAW occupying what is called a 'Layer'. If you only use one DAW, then it is likely you'll only need one layer. If using multiple DAWs, simply click in the **LAYER 2** or **LAYER 3** tabs to configure as appropriate.

2 - DAW Profile Selection

Use the drop-down list to select your DAW for the chosen layer.

3 - PORT INFO

Clicking on **PORT INFO** provides some basic instructions on how to configure your **SSL V-MIDI** ports correctly (useful as a reminder). If you are configuring UF8 for the first time, please refer to the more detailed explanations found at the start of each DAW Tutorial section as the **PORT INFO** does not cover every detail.

4- REVERT

Allows you to revert this Layer to the factory-shipped DAW profile.

5 - DAW Command/Keyboard Shortcut Assignments

Clicking on the pen symbol will allow you to change the assignment of any of the user-assignable keys. See the next page for more information.

6 - Short Label

Using your computer keyboard, you can type the label that you wish to appear on the UF8 LCD just below the User Key.

7 - Profile Name and **SAVE/LOAD/SAVE AS** Buttons

Allows you to save your customised DAW profiles as an .xml file to your computer or any connected hard-drives. The name of the currently active profile is shown above these buttons. If you have made any changes to the saved profile, then an asterisk (*) is appended to indicate this.

Built-in Auto-Saving Feature

Changes you make to the software are automatically stored in the background, so you don't need to worry about remembering to save each time you change something in SSL 360° software.

User-Assignable Keys

A number of keys on UF8 are user-assignable and can be changed from their factory shipped assignments. Each UF8 unit has the following user-assignable keys:

5 x banks of 8 Top-Row Soft Keys, accessed by **SOFT KEY** buttons **1-5** in the top-right of UF8.

3 x **QUICK** Keys

2 x Foot-switches

All of these keys can have either DAW commands or keyboard shortcut sequences assigned to them.

Assigning DAW Commands

Clicking on the pen symbol for any user-assignable key will bring up a pop-up window, from which **DAW command** can be selected using the radio buttons on the left-hand side. To assign a different DAW command to the button in question, simply select one from the list of available HUI/MCU commands. The **SHORT LABEL** text field allows you to enter the label you want to appear on the LCD to accompany this command. The list of available commands depends on the selected DAW.

Assigning Keyboard Shortcut Sequences

If you would like to assign a keyboard shortcut sequence, select the **Keyboard command** option. Once selected, simply click your mouse cursor into the area that says '**Type your commands here...**' and use your keyboard to enter the desired key press or sequence. Should you make a mistake and need to start again, you can use the **CLEAR** button. The **SHORT LABEL** text field allows you to enter the label you want to appear on the LCD to accompany this keyboard shortcut sequence.

ADVANCED Setup Options

Transport Master

If you are running multiple DAWs that are linked using MIDI timecode, then you can designate 1 of the 3 DAW profile layers to be transport master. This means that the transport keys will always trigger from the DAW assigned as Transport Master, even if your UF8 is controlling a different DAW Layer.

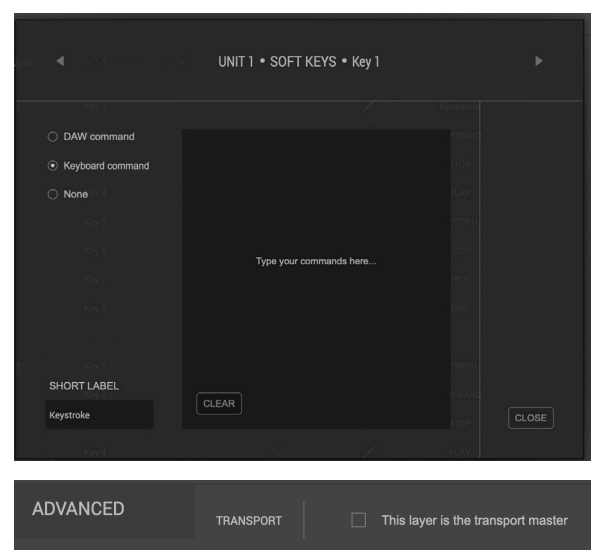
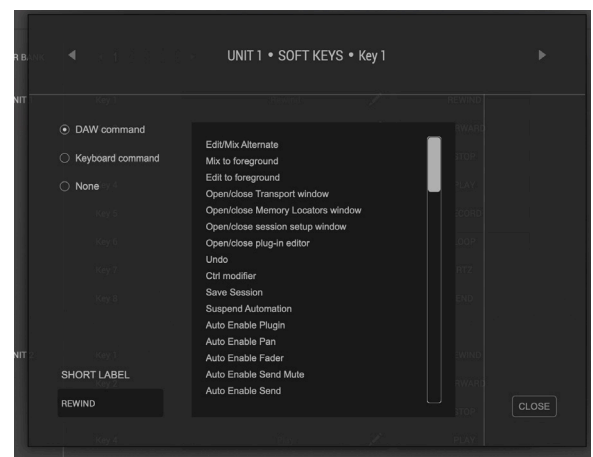

ADVANCED Setup Options - HUI

The following tick-box options are presented for Pro Tools profile selections only:

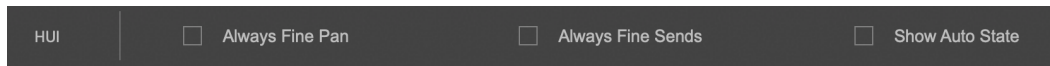

Always Fine Pan - Enabling this option will automatically change the operation of the V-Pots to **FINE** mode when controlling pans. This will also cause the Pan position to be displayed on the LCD whilst being turned.

Always Fine Sends - Enabling this option will automatically change the operation of the V-Pots to **FINE** mode when controlling Sends. This will also cause the Send level to be displayed on the LCD whilst being turned.

Show Auto State - Enabling this option will display an indication of the Pro Tools automation state (READ/WRITE/TRIM) per channel, just above the DAW metering on the LCD at all times. If TRIM is engaged, the indication will flash between TRIM and READ or TRIM and WRITE.

"I wish I was blank, I wish I was blank, I wish I could thank, I wish I was blank" - Blank, The Smashing Pumpkins.

DAW Communication

SSL V-MIDI Ports

UF8 communicates with your DAW using hi-speed USB MIDI communication via a specialised MIDI driver, installed as part of the SSL 360° software. The driver is presented on your computer system as 'virtual' midi ports called **SSL V-MIDI**.

The number of **SSL V-MIDI** Ports you'll need to configure in your DAW depends upon the number of UF8s you have connected. The table below illustrates how the SSL 360° software maps the virtual midi ports to each of your connected UF8s.

DAW LAYER	1st UF8 Unit	2nd UF8 Unit	3rd UF8 Unit	4th UF8 Unit
1	SSL V-MIDI Port 1	SSL V-MIDI Port 2	SSL V-MIDI Port 3	SSL V-MIDI Port 4
2	SSL V-MIDI Port 5	SSL V-MIDI Port 6	SSL V-MIDI Port 7	SSL V-MIDI Port 8
3	SSL V-MIDI Port 9	SSL V-MIDI Port 10	SSL V-MIDI Port 11	SSL V-MIDI Port 12

Each DAW varies slightly in the way in which it requires MIDI controller(s) to be setup and these steps are covered in detail in each of the DAW Tutorials.

DAW Protocols

SSL V-MIDI provides the means of communication between UF8 and the DAW but the protocol (or in other words 'language') that is being spoken depends on the DAW's preferred method of communication with external control surfaces. Furthermore, even DAWs that use the same protocol vary in their application of that protocol (you could draw an analogy to varying dialects found within different geographical regions of the same country). Each DAW Tutorial will aim to guide you through each DAW's implementation of the protocol that they have chosen to implement and how it applies to UF8.

HUI

The HUI (Human User Interface) protocol is the way in which Pro Tools communicates with UF8. In addition to the HUI protocol, we have added a number of features such as **CHANNEL** and **PLUGIN** mode, which provide an enhanced workflow for those using UF8 with Pro Tools.

MCP/MCU

The MCP (Mackie Control Protocol), also commonly referred to as MCU, is the way in which many DAWs such as Logic, Cubase/ Nuendo, Live and Studio One communicate with UF8. The implementation of MCU differs between DAWs and traditionally, if you had an MCU control surface and were not using Logic, you would have to place a special overlay onto the surface so that the buttons were labelled with the correct functions. With UF8 we have designed the surface in such a way to eliminate the need for any special overlays, in part by using the top-zone of the LCDs to provide labels for the functions hosted on the buttons that reside just above. The functions and labelling of the buttons dynamically change, as appropriate, depending on the currently loaded DAW profile.

Pro Tools with UF8 - Tutorial

The following tutorial guides you through configuring and using the default Pro Tools profile on **LAYER 1** of UF8. If you wish to configure Pro Tools on a different layer, please refer to the *DAW Communication* section of this User Guide to ensure your DAW is configured for the correct **SSL V-MIDI** ports.

SSL 360° Setup

1. Open the SSL 360° application on your Mac or Windows computer and on the **HOME** page check that any UF8s you have connected to your computer are present - outline images of each UF8 appear on screen.
2. If you have multiple UF8s connected, click down on the image of each unit to check that the UF8s are arranged in the correct order. If units need to be re-ordered, then click and drag with your mouse to re-arrange.
3. Go to the **UF8** page and set **LAYER 1** to **Pro Tools** using the drop-down list.

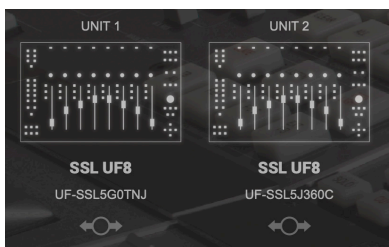

STEP 1 : Open SSL 360° application. Connected UF8s appear on-screen.

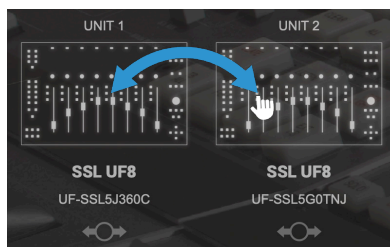

STEP 2 : Click and drag to re-order units if necessary.

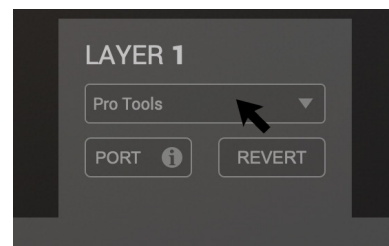

STEP 3 : Select the default Pro Tools DAW profile from the UF8 page.

Pro Tools Setup

4. Open Pro Tools. Go to the **Setup** Menu > **MIDI** > **MIDI Input Devices...**. In this list, ensure that any **SSL V-MIDI** Ports you need are ticked. e.g. If you have 1 UF8, just tick **SSL V-MIDI Port 1 Source**. If you have 2 UF8s, tick **SSL V-MIDI Port 1 Source** and **SSL V-MIDI Port 2 Source** etc.
5. Go to the **Setup** Menu > **Peripherals** > **MIDI Controllers** tab. Configure each UF8 unit as a **HUI** Type. Set the first unit to **Receive From SSL V-MIDI Port 1 Source** and then **Send To** as **SSL V-MIDI Port 1 Destination**. Repeat for all subsequent UF8s, incrementing the port number each time.

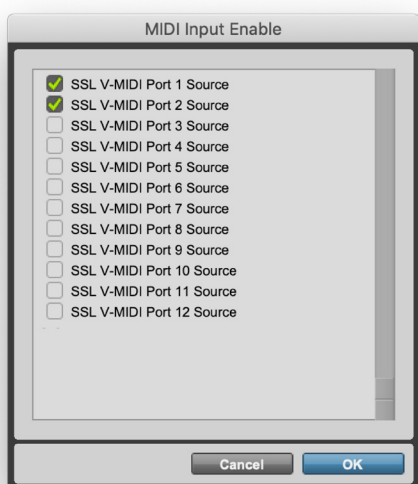

STEP 4 : Enable SSL V-MIDI Port(s) in Pro Tools.

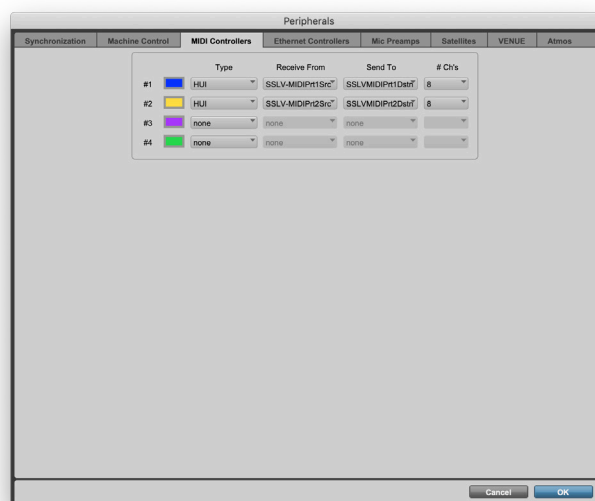

STEP 5 : Setup each UF8 as a HUI Controller, incrementing the SSL V-MIDI port number for each additional HUI.

LCD Layout

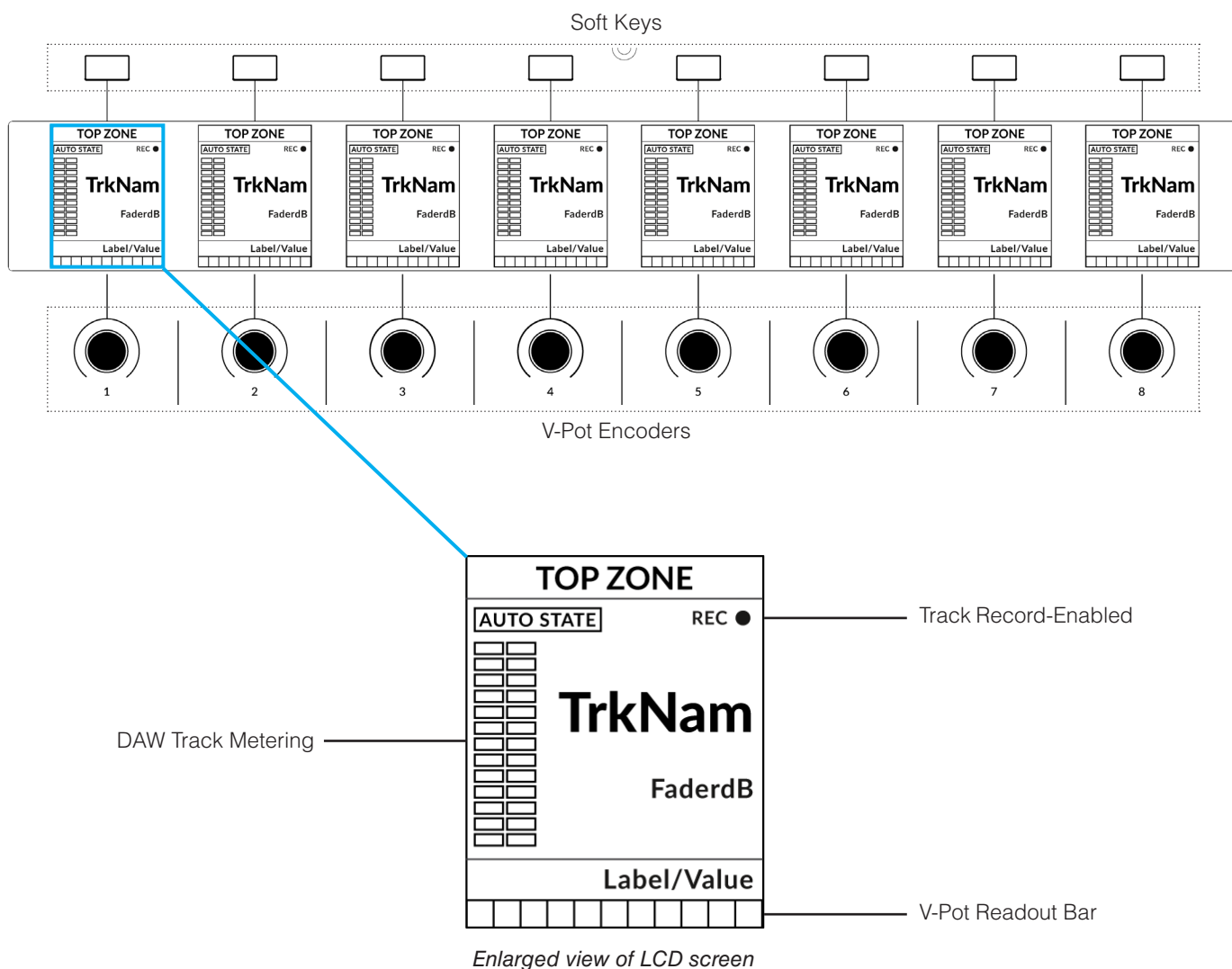

Top Zone - Provides a label for the function assigned to the soft key directly above.

Auto State - Shows the current automation state of the track (when **Show Auto** is enabled in SSL 360°).

Track Record Enabled (REC) - Indicates that the track has been record-enabled.

TrkNam - Displays the 4-character track name.

FaderdB - Provides a readout of the current fader position.

Label/Value - Displays a label or value readout for the parameter currently assigned to the V-Pot.

DAW Track Metering - 12-segment track metering + clip

V-Pot Readout Bar - Displays the position of the currently assigned V-Pot function.

*Track Metering Power Tip: The **F1** command, available in the DAW commands list SSL 360° will clear clips on the track metering. You can assign this command to any of the Quick Keys or User keys on UF8. Alternatively, you'll find this command pre-assigned to the 6th Soft Key in User Bank 3.*

Tutorial

This section guides you through using UF8 with Pro Tools.

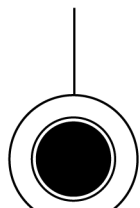

1

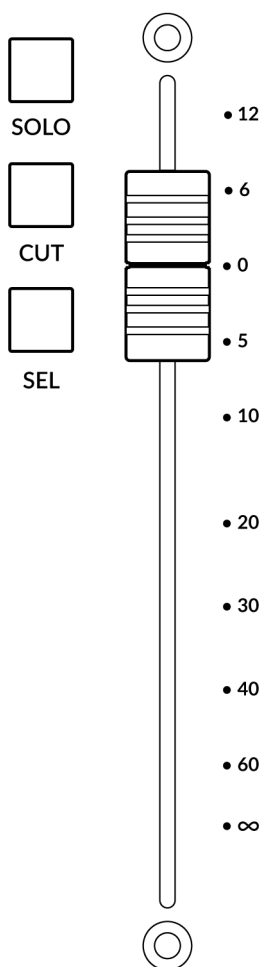

V-Pot

At the top of each strip is the V-Pot (virtual pot). The function of the V-Pot varies, depending on which V-Pot assignment mode is currently active (Pan, Send etc). These modes are explained on the pages that follow.

100 mm Motorised Fader

Motorised, touch-sensitive faders provide physical control of your Pro Tools tracks and are great for balancing mix levels and riding volume automation.

Solo, Cut & Sel (Select)

Each strip contains **SOLO**, **CUT** and **SEL** keys corresponding to the solo, mute and select features for each track in Pro Tools.

In Use:

When solo'ing tracks, expect the **CUT** keys of UF8 to flash on all tracks that are not solo'd.

Double-pressing a **SEL** key will open up the Pro Tools re-name track window on your computer screen.

The non-contiguous selection of multiple **SEL** keys can be achieved by pressing and holding the first **SEL** key you want to select and then pressing subsequent **SEL** keys.

Holding the **Shift/All** modifier key (found within **SOFT KEY** User Bank 3) and pressing the **SEL** keys will allow you to select a contiguous range of **SEL** keys.

Holding the **Opt/Alt** modifier key (also found within **SOFT KEY** User Bank 3) and pressing a **SEL** key will allow you to toggle the selection of all **SEL** keys.

Selection Mode

The primary purpose of the **NORM**, **REC** and **AUTO** keys in the **SELECTION MODE** section is to determine the behaviour of the **SEL** keys. These 3 modes inter-cancel.

NORM - The **SEL** keys behave as normal track selection functions of Pro Tools.

REC - The **SEL** keys become track record-arm buttons.

AUTO - The **SEL** keys become Automation Select keys and can be used in conjunction with the **AUTOMATION** state keys found on the bottom-left corner of UF8.

SELECTION MODE

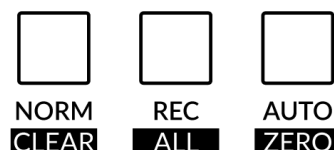

Secondary Functions Of The Selection Mode Keys

You will notice that there are additional labels beneath the **SELECTION MODE** keys - **CLEAR**, **ALL** and **ZERO**. These functions are accessed by a press and hold action and provide useful additional workflow features:

Clear Solos - Press and hold **CLEAR** and then press any **SOLO** key to clear solos.

Clear Mutes/Cuts - Press and hold **CLEAR** and then press any **CUT** key.

Clear Selection Keys - Press and hold **CLEAR** and then press any active **SEL** key.

Record-Arm All Tracks - Press and hold **ALL** and then press any **SEL** key.

Zero Fader(s) - Press and hold **ZERO** and then press **SEL** key. This will also work if you have multiple tracks selected.

Zero All Faders - Press and hold the **ALL** and **ZERO** keys together and then press any **SEL** key.

Channel Encoder

By default, the **CHANNEL** encoder is used to move your DAW tracks across the UF8 surface, in increments of one channel at a time. If you find yourself in **NAV**, **NUDGE** or **FOCUS** modes, simply push the **CHANNEL** encoder to return to **CHANNEL** mode.

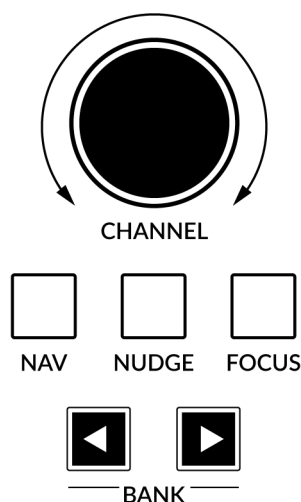

Nav

Pressing the **NAV** key changes the **CHANNEL** encoder to operate the playhead position in Pro Tools, allowing you to navigate through your session.

Nudge

Pressing the **NUDGE** key puts the **CHANNEL** encoder into Nudge mode, which will allow you to move selected audio regions backwards and forwards by the Nudge value you have set within Pro Tools.

Focus

Pressing the **FOCUS** key puts the **CHANNEL** encoder into Focus mode, which emulates the scroll function of a mouse. This can be a really nice way of controlling plug-ins or anything else on screen that responds to a mouse scroll operation. Simply open a plug-in, hover your computer mouse over a control and turn the encoder for hands-on control. The sensitivity of **FOCUS** mode will vary depending on what plug-in or on-screen element you are controlling. You can use the mouse scroll sensitivity setting in your computer preferences to adjust to taste.

Scroll Into View

The 'Scroll Into View' feature offered by Pro Tools is a handy way to select a track within Pro Tools and make it the first track on your UF8 surface.

In Pro Tools, simply right-click with your mouse in the selected track area (white area) and choose 'Scroll Into View'.

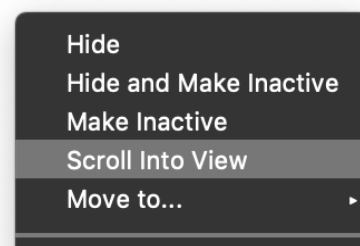

Bank Keys

The **BANK < >** keys allow you to move tracks across your UF8 control surface(s) in multiples of 8, depending on how many UF8s are connected. e.g. 8 for one UF8, 16 for 2 UF8s etc.

Cursor Keys and Mode Key

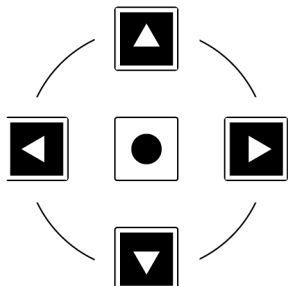

In the lower-right corner of your UF8 are the Cursor keys with the Mode key in the centre.

When the Mode key is lit the cursor keys perform horizontal and vertical zooming.

Pressing the Mode key again, the left and right cursors move between audio clip edit points, or, tab between transients if Tab To Transient is active in Pro Tools. Up and down will move the edit cursor between tracks.

Automation

You can select the automation mode for each track directly from UF8. To do this, you will first need to put the surface into **AUTO** (Automation) **SELECTION MODE**. Then, select a track you want to change the automation state of using the **SEL** key(s). Finally, press the desired automation state from the **AUTOMATION** keys in the lower-left corner of UF8.

SELECTION MODE

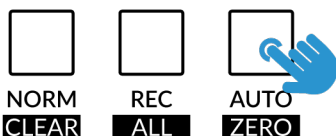

STEP 1 : Select AUTO Selection Mode.

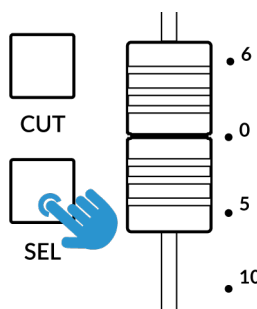

STEP 2: Use the SEL key(s) to select track(s).

AUTOMATION

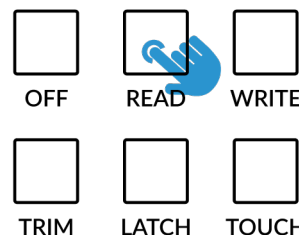

STEP 3: Select the desired automation state.

Multiple tracks can be selected at once using the Shift/All (contiguous) and Opt/Alt modifier keys (all). Non-contiguous selections can be achieved pressing and holding the first SEL key and then pressing subsequent SEL keys.

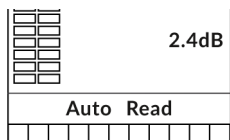

Selected tracks will show their current automation state next to the **Auto** text in the lower section of the LCD. Please note that V-Pots have no functionality when **AUTO** selection mode is active. You must return to **NORM** or **REC**.

Show Auto State

Within SSL 360°, on the UF8 page under **ADVANCED** there is the tick-box option for **Show Auto State**. Enabling this will provide a constant indication (regardless of selection mode) of the current automation state of each track in the top-left of the LCD - **READ**, **WRITE** or **TRIM**.

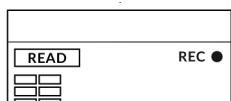
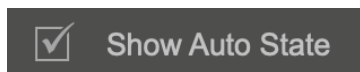

Quick Keys

The three **QUICK** keys located at the top-left of UF8 are user-assignable keys that are best used for access to your most frequently needed DAW commands or keyboard shortcuts. By default, they are assigned to the following commands but can of course be changed in SSL 360°.

Default Quick Key Assignments:

- 1 - Toggle Edit and Mix Window
- 2 - Toggle Floating Transport Window Open/Close
- 3 - Toggle Session Setup Window Open/Close

QUICK



Pan



Pressing the **PAN** key once will assign the V-Pots to control the track pans. The V-Pot readout bar will display the pan position on the LCD. Press the **PAN** key again (it will pulse) to toggle the V-Pots into controlling the right-hand pan for stereo tracks. Pushing a V-Pot will default a pan to the centre position.

Fine

Press and hold the **FINE** key whilst turning a V-Pot that is controlling Pans or Sends, to operate in a fine resolution. Doing this will also show you the current Pan or Send value on the LCD. Ignore the Shift label, this is applicable for when UF8 is working with Cubase.



If you prefer the FINE behaviour and would like FINE mode to be engaged automatically every time you turn a V-Pot in Pan or Send modes, you can enable the 'Always Fine Pan' and/or 'Always Fine Sends' in SSL 360°, on the UF8 page under ADVANCED settings.

Sends

Number keys **1-5** in the **SEND / PLUGIN** section will allow you to control send levels A-E on the V-Pots. The V-Pot readout bar will display the Send position on the LCD. Pushing on the V-Pot will default a send to 0 dB. Keys 6-8 are disabled as they are not made available for control by Pro Tools.

- 1 = Send A
- 2 = Send B
- 3 = Send C
- 4 = Send D
- 5 = Send E

SEND / PLUGIN



Pre/Post

Sends can be toggled between their pre/post state using the Soft Keys on UF8. Ensure the Soft Keys are in V-Pot mode, by pressing the **V-POT** button in the **SOFT KEYS** selection area, then simply use the relevant Soft Key to toggle between post/pre states for each Send as desired.

SOFT KEYS

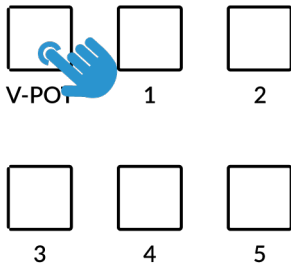

STEP 1 : Select V-POT Soft Keys Mode.

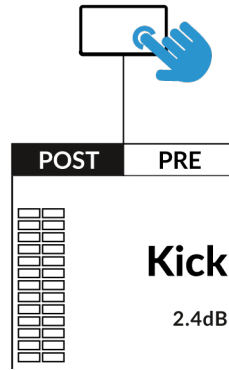

STEP 2: Use the Soft Keys to toggle Sends between post and pre.

Send Mutes

The Soft Keys can also be used to toggle Send Mutes on/off. Simply press the **V-POT** button a second time to toggle into Send Mute Mode.

SOFT KEYS

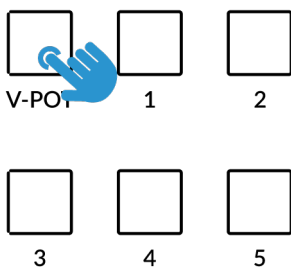

STEP 1 : Press V-POT a second time to toggle Soft Keys keys into Send Mute Mode.

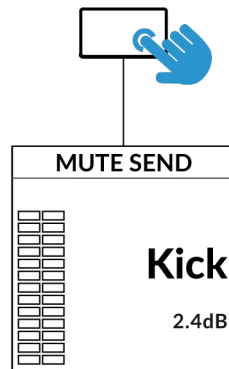

STEP 2: Use the Soft Keys to toggle Send Mutes on/off.



Flip

Sends can be flipped to the faders using the **FLIP** key. This is useful for riding Send levels or creating headphone mixes using faders instead of V-Pots. In **FLIP** mode, the V-Pots control the Pan of the currently selected Send.

Channel Mode

Channel Mode allows you to access Sends A-E and the Pan of the selected track, all from one place. This is a unique UF8 control feature, that utilises the touch-sense encoders to automatically switch send selection.

1. To enter and exit Channel Mode, press the **CHANNEL** key.
2. Select a track that you wish to control the Sends and Pans on using a **SEL** key.
3. Use V-Pots 1-5 to control Sends A-E or V-Pot 8 to control Pan.



CHANNEL

STEP 1 : Enter Channel Mode by pressing the CHANNEL key.

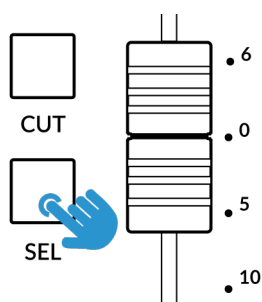

CUT

SEL

STEP 2: Use a SEL key to select a track.

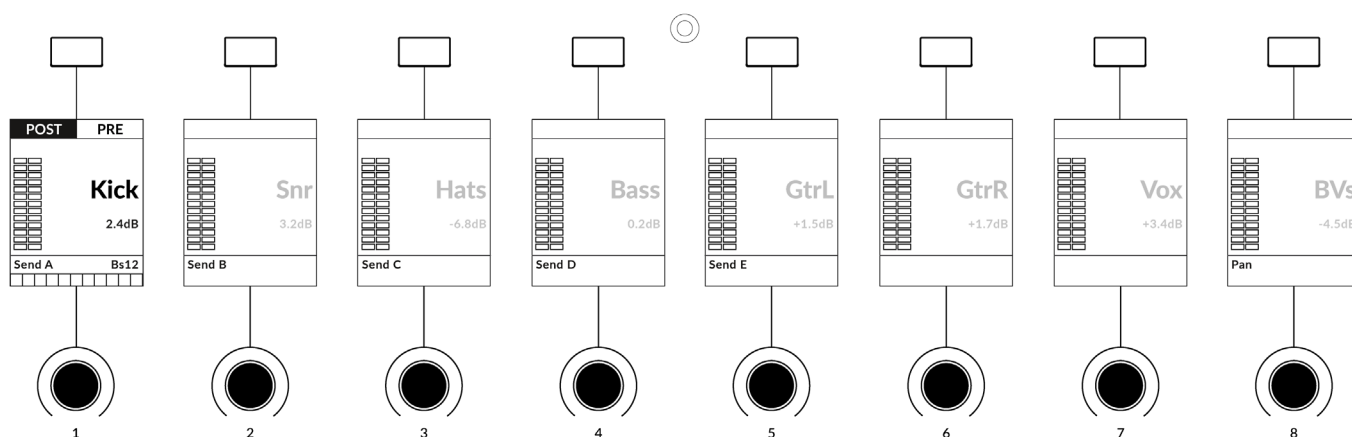

STEP 3: Use V-Pots 1-5 to control Sends A-E and V-Pot 8 to control Pan.

Working in Channel Mode

- Channel Mode turns the **SEL** keys and LCDs purple to indicate that you're working in Channel Mode.
- All non-selected tracks are dimmed on the LCDs to make it clear that you're working with Sends & Pan on the *selected track*.
- The V-Pot readout bar, together with a bus name label will appear on screen whilst the V-Pot is being touched and revert to the idle screen state 3-seconds after touch is released.
- Pre/Post States can also be toggled for each send using the corresponding Soft Key.
- Simultaneous adjustment of more than one V-Pot and **FLIP** mode are not possible in Channel Mode.

Plug-in Mode

Plug-in Mode provides a smart way of accessing plug-in parameters for Inserts A-E of the selected track, whilst automatically opening the plug-in GUI at the same time.

1. To enter and exit Plug-in Mode, press the **PLUGIN** key.
2. Use a **SEL** key to select a track.
3. Press one of the number keys **1-5** (corresponding to Insert Slots A-E).



PLUGIN

STEP 1 : Enter Plug-in Mode by pressing the **PLUGIN** key.

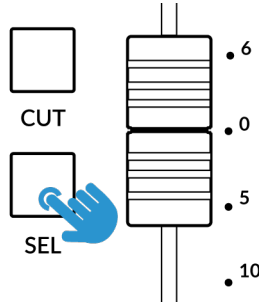

STEP 2 : Use a **SEL** key to select a track.

SEND / PLUGIN

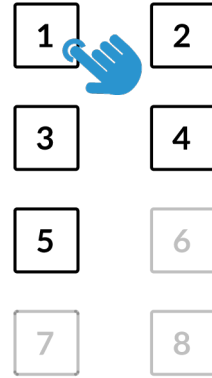

STEP 3 : Select an insert slot using the number keys.

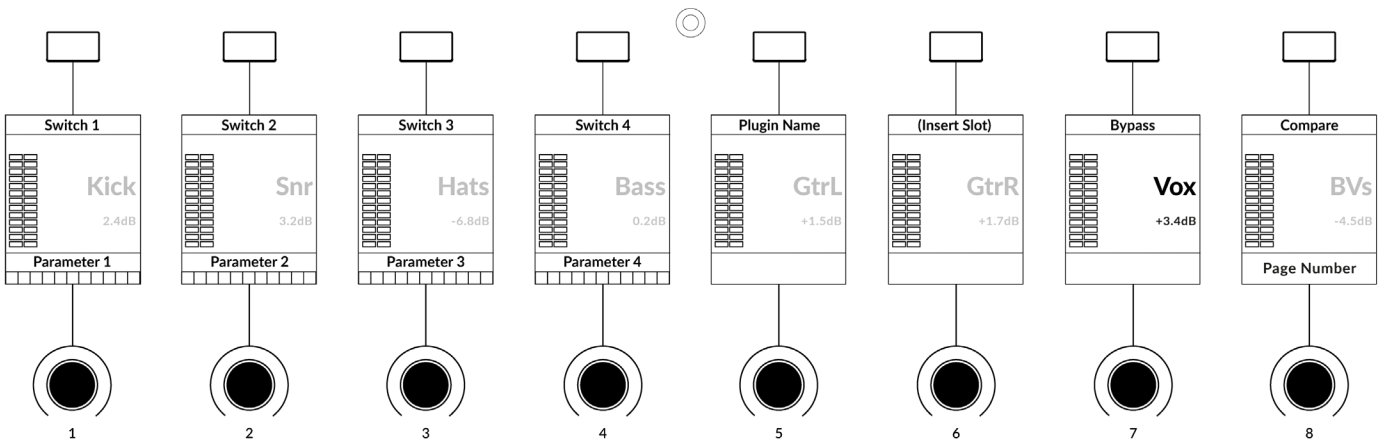

Working in Plug-in Mode

- Plug-in Mode turns the **SEL** keys and LCDs cyan to indicate that you're working in Plug-in Mode.
- In the Pro Tools session, you will see the currently selected insert slot on screen have a thin blue outline around it - please note when working in Plug-in Mode, you will not see the Pro Tools track selection itself change.
- All non-selected tracks are dimmed on the LCDs to make it clear you're working on the **selected track only**.
- The parameters of each plug-in will be laid out on V-Pots 1-4 and Soft Keys 1-4.
- Use the **PAGE < >** keys or the 8th V-Pot to access the various pages of parameters for each plug-in.
- Pro Tools' **Compare** and **Bypass** plug-in features can be actioned using Soft Keys 7 and 8.
- The F5 command, available in the DAW commands list (also pre-assigned to the 7th Soft Key in User Bank 3) allows you to toggle the V-Pots between Fixed and Velocity-Sensitive modes, which apply to controlling plug-ins specifically.



Use the **Page** keys to move through the plug-in parameter pages

- Although you cannot select Insert Slots F-J directly from UF8 (Pro Tools does not make them available), once you have selected a track and opened a plug-in in Slots A-E using the number keys, you can click with your mouse on-screen in Pro Tools on any Insert Slot in F-J and the UF8 surface will be able to control the parameters.
- When automating plug-in parameters in Plug-in Mode, any plug-in parameters in a write-ready automation state will show the current V-Pot bar segment flashing, before changing to become solid when writing automation.

When working with multiple UF8s, the tracks on which you want to control the plugin(s) must be banked down to the first UF8 surface.

User Bank Pre-Assignments

User Banks 1-5 allow you access to various DAW commands or keyboard shortcuts on the 8 soft keys along the top of UF8. These can of course be changed to any of the available DAW commands or your own keyboard shortcut sequences in the UF8 page of SSL 360°.

Select User Banks using Keys **1-5** in the **SOFT KEYS** section.

SOFT KEYS

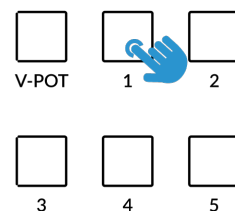

User Bank 1

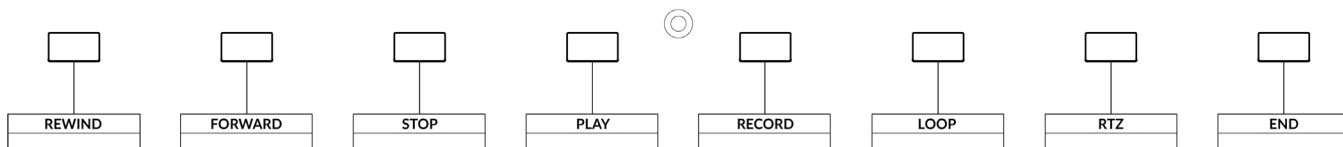

User Bank 2

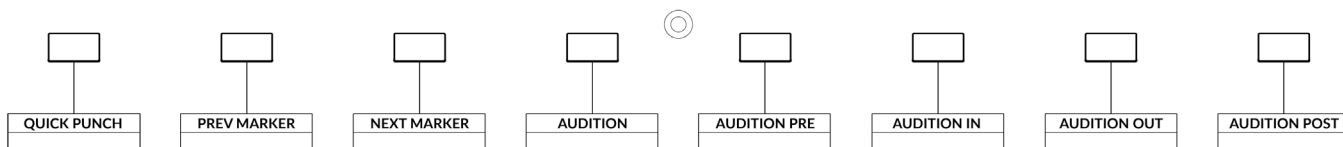

User Bank 3

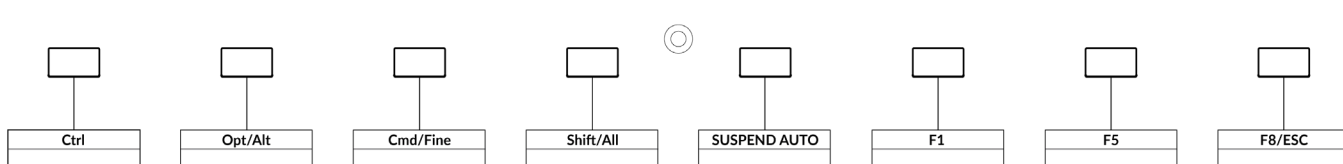

User Bank 4

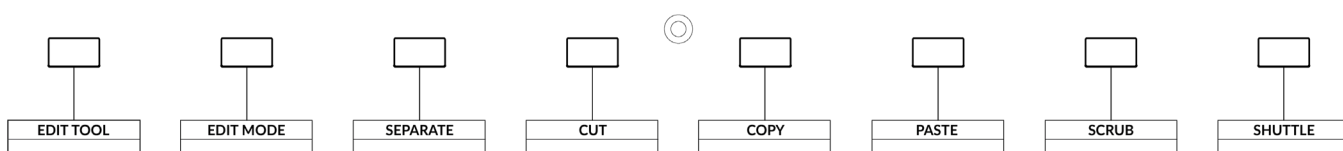

User Bank 5 (Empty)

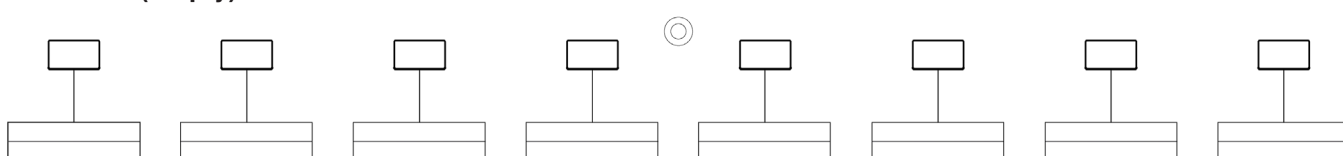

Assignable DAW Commands List - Pro Tools

The following DAW commands are available in SSL 360° to assign to any of the user-assignable keys.

Edit/Mix Alternate	Edit Cut
Mix to foreground	Edit Copy
Edit to foreground	Edit Paste
Open/close Transport window	Edit Delete
Open/close Memory Locators window	Status Auto
Open/close Session Setup window	Status Monitor
Open/close plug-in editor	Status Group
Undo	Group Suspend
Ctrl Modifier	Group Create
Save Session	Play Foot-switch
Suspend Automation	Record Foot-switch
Auto Enable Plug-in	Scrub
Auto Enable Pan	Shuttle
Auto Enable Fader	Default
Auto Enable Send Mute	Kpad Clr
Auto Enable Send	Kpad =
Auto Enable Mute	Kpad *
Option/Alt modifier	Kpad -
Cmd/Fine modifier	Kpad +
Shift/All modifier	Kpad .
Edit Tool	Kpad Enter
Edit Mode	Kpad 0
Fkey 1	Kpad 1
Fkey 5	Kpad 2
Fkey 8/Esc	Kpad 3
Audition	Kpad 4
Audition Pre	Kpad 5
Audition In	Kpad 6
Audition Out	Kpad 7
Audition Post	Kpad 8
RTZ	Kpad 9
End	
Online	
Loop	
Quick Punch	
Forward	
Rewind	
Stop	
Play	
Record	
Next Marker	
Previous Marker	
Last Marker	
Reset Marker	
Edit Capture	
Edit Separate	

Logic with UF8 - Tutorial

The following tutorial guides you through configuring and using the default Logic profile on **LAYER 1** of UF8. If you wish to configure Logic on a different layer, please refer to the *DAW Communication* section of this User Guide to ensure your DAW is configured for the correct **SSL V-MIDI** ports.

SSL 360° Setup

1. Open the SSL 360° application on your Mac or Windows computer and on the **HOME** page check that any UF8s you have connected are present - outline images of each UF8 appear on screen.
2. If you have multiple UF8s connected, click down on the image of each unit to check that the UF8s are arranged in the correct order. If units need to be re-ordered, then click and drag with your mouse to re-arrange.
3. Go to the **UF8** page and set **Layer 1** to **Logic** using the drop-down list.

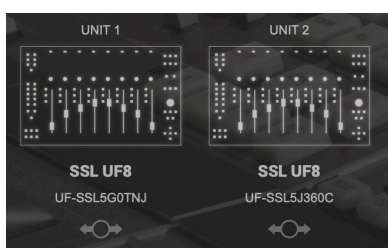

STEP 1 : Open SSL 360° application. Connected UF8s appear on-screen.

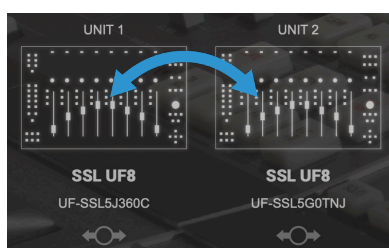

STEP 2 : Click and drag to re-order units if necessary.

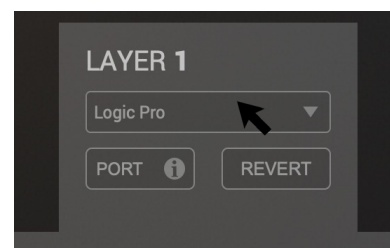

STEP 3 : Select the default Logic DAW profile from the UF8 page.

Logic Setup

4. Open Logic. Go to **Control Surfaces** > **Preferences...** and then go to the **Advanced** tab. Make sure **Control Surfaces** is ticked under **Additional Options**.
5. Within the same **Preferences** menu, go to the **Control Surfaces** > **General** tab and ensure that 'Multiple Controls Per Parameter' is set to '1' and 'Only when all parameters fit one page' is unticked. Also, increase 'Maximum MIDI Bandwidth' to 100%.
6. Go to the **Help Tags** tab and ensure that 'Parameter name' and 'Parameter value' are both unticked.

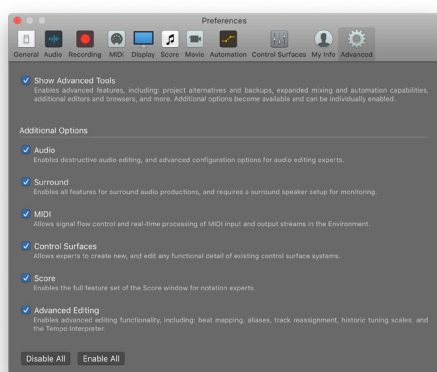

STEP 4 : On the 'Advanced Tab', tick 'Control Surfaces' in the 'Additional Options' section.

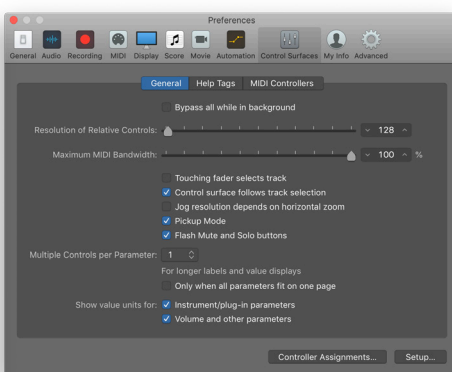

STEP 5 : On the 'Control Surfaces' > 'General' tab ensure that 'Multiple Controls per Parameter' is set to '1' and 'Only when all parameters fit on one page' is unticked. Set 'Maximum MIDI Bandwidth' to 100%.

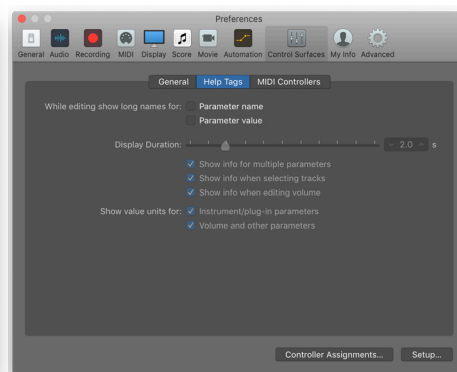

STEP 6 : On the 'Control Surfaces' > 'Help Tags' tab, ensure that 'Parameter name' and 'Parameter value' are both unticked.

7. Go to **Preferences > MIDI** and select the **Inputs** tab. In this list, ensure that any **SSL V-MIDI** Ports you need are ticked. e.g. If you have 1 UF8, just tick **SSL V-MIDI Port 1 Source**. If you have 2 UF8s, tick **SSL V-MIDI Port 1 Source** and **SSL V-MIDI Port 2 Source** etc.

Versions of Logic preceding 10.5 may not have the 'Inputs' tab available. If so, you can skip this step, as all MIDI ports default to be turned on.

8. Go to the **Control Surfaces > Setup**. Click **New > Install...** from the drop-down list in the top-left of the window. From the list, choose **Mackie Designs | Mackie Control | Logic Control** and click the **Add** button. Click on the image of the Mackie Control that has been added to the window and in the device setup options list on the left-hand side, configure the **Output Port** to **SSL V-MIDI Port 1 Destination** and set the **Input Port** to **SSL V-MIDI Port 1 Source**.

Subsequent UF8s should be set up as extender units i.e. **Mackie Designs | Mackie Control Extender | Logic Control** and their input and output ports increased incrementally for each UF8. e.g. a second UF8 is set up as a **Mackie Control Extender**, with Input and Output Ports assigned to **SSL V-MIDI Port 2**.

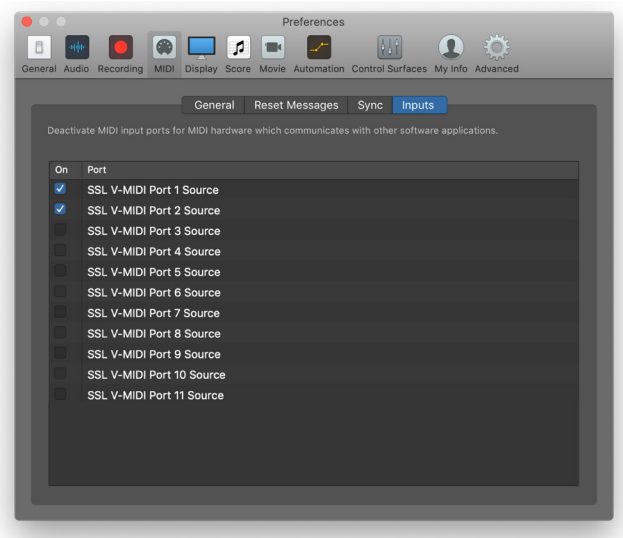

STEP 7 : Enable SSL V-MIDI Port(s) in Logic.

If you're working with a version of Logic that precedes 10.5, then skip this step.

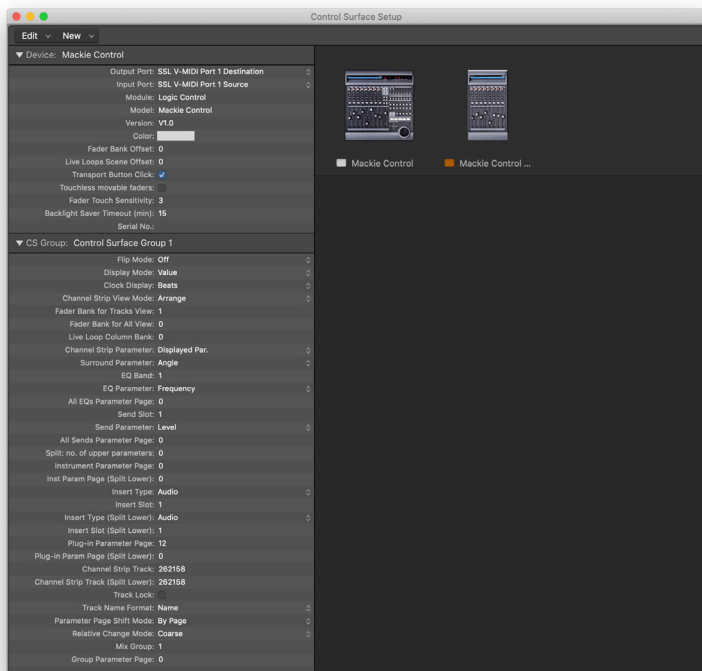

STEP 8 : Set up the first UF8 as a Mackie Control Unit and subsequent UF8s as Mackie Control Extenders, incrementing the SSL V-MIDI Port number for each Extender.

If you do not see the device setup options list on the left-hand side, press 'i' on your computer keyboard to show it.

Ensure that each Mackie Control Extender (additional UF8) has the 'Fader Bank Offset' setting in the device setup options list set to '8' for the second UF8, '16' for the third and '24' for the fourth.

Ensure that 'Channel Strip View Mode' is set to 'Arrange' in the device setup options list, to ensure that UF8 follows the order of tracks in your Logic arrangement.

LCD Layout

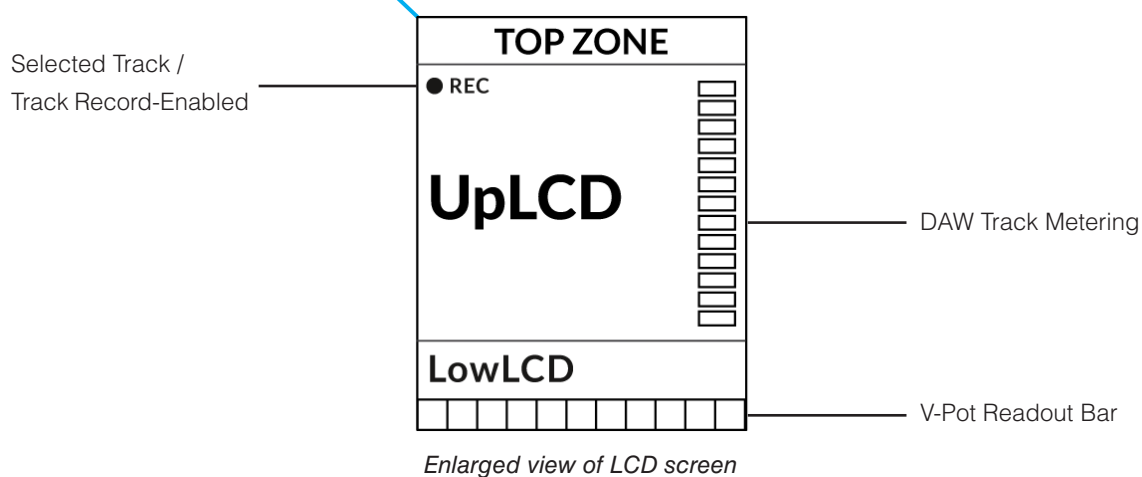
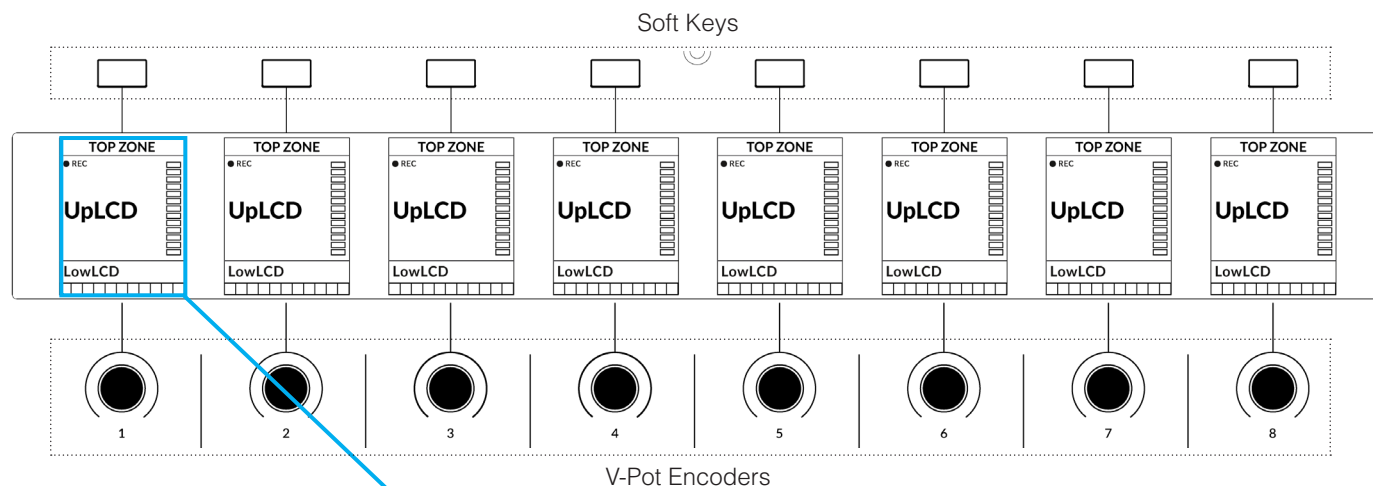

Top Zone - Provides a label for the function assigned to the soft key directly above.

Selected Track / Track Record-Enabled (REC) - In Logic, the **REC** text follows the currently selected track. If the track is record-enabled, the **REC** text pulses.

UpLCD - Displays the 6-character track name.

LowLCD - Displays a label or value readout for the parameter currently assigned to the V-Pot.

DAW Track Metering - 12-segment track metering + clip

V-Pot Readout Bar - Displays the position of the currently assigned V-Pot (encoder) function.

Tutorial

This section guides you through using UF8 with Logic.

Before You Start...

The information in this Logic Tutorial sets out the key features of using UF8 with Logic.

For complete, in-depth coverage of all the functions and features you can control in Logic using UF8, please refer to the Logic **Help Menu > Logic Pro Control Surface Support** document. Open the document and go to the **Mackie Control** section.

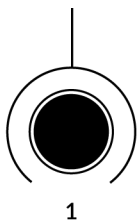
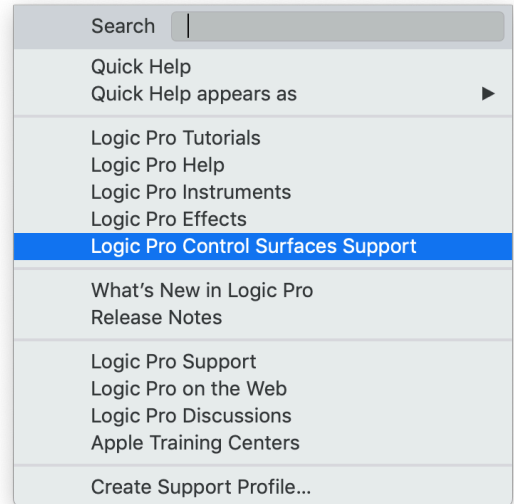

V-Pot

At the top of each strip is the V-Pot (virtual pot). The function of the V-Pot varies, depending on which V-Pot assignment mode is currently active (Pan, Send etc) but it is typically used for tasks such as controlling Pan position, Send levels, Plug-in parameters or scrolling through parameter options/lists.

The Mackie Control section of the Logic Pro Control Surfaces Support contains a full Mackie Control Protocol guide.

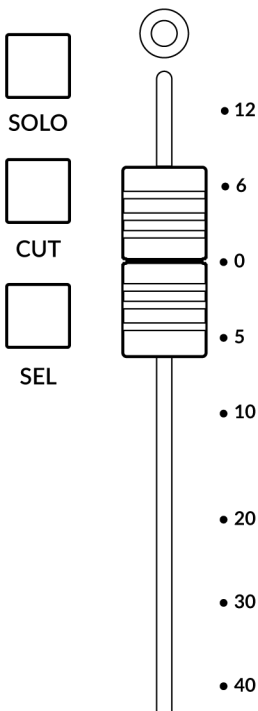

The V-Pot has a push function, which is typically used for either defaulting the position of a parameter being controlled or confirming the selection of a parameter being chosen.

100 mm Motorised Fader

Motorised, touch-sensitive faders provide physical control of your Logic tracks and are great for balancing mix levels and writing automation.

Solo, Cut & Sel (Select)

Each strip contains **SOLO**, **CUT** and **SEL** keys corresponding to the solo, mute and select features for each track in Logic.

In Use:

When solo'ing tracks, expect the **CUT** keys of UF8 to flash on all tracks that are not solo'd if the Logic Control Surface preference 'Flash Mute and Solo Buttons' is ticked.

In Logic MCP (Mackie Control Protocol), only one track can be selected using the **SEL** key at a time.

Selection Mode

The primary purpose of the **NORM** and **REC** keys in the **SELECTION MODE** section is to determine the behaviour of the **SEL** keys.

NORM - The **SEL** keys behave as the standard track selection function of Logic.

REC - The **SEL** keys become track record-arm buttons.

AUTO - Disabled. This key only applies for Pro Tools profiles.

SELECTION MODE

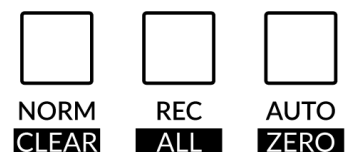

Secondary Functions Of The Selection Mode Keys

You will notice that there are additional labels beneath the **SELECTION MODE** keys. These functions are accessed by a press and hold action and provide useful additional workflow features in Logic:

Clear Solos

Press and hold **CLEAR** and then press any **SOLO** key.

Clear Mutes/Cuts

Press and hold **CLEAR** and then press any **CUT** key.

Zero Fader

Press and hold **ZERO** and then press a **SEL** key (**SEL** key must not be currently selected one).

Channel Encoder

By default, the **CHANNEL** encoder is used to move your DAW tracks across the UF8 surface, in increments of 1 channel at a time. If you find yourself in **NAV** or **FOCUS** modes, simply push the **CHANNEL** encoder to return to **CHANNEL** mode.

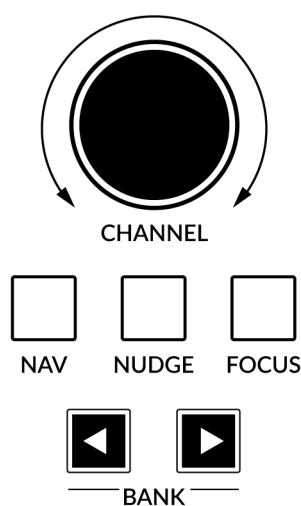

Nav

Pressing the **NAV** key changes the **CHANNEL** encoder to operate the playhead position in Logic, allowing you to navigate through your session.

Nudge

Disabled. Only applies to Pro Tools profiles.

Focus

Pressing the **FOCUS** key puts the **CHANNEL** encoder into Focus mode, which emulates the scroll function of a mouse. This can be a really nice way of controlling plug-ins or anything else on screen that responds to a mouse scroll operation. Simply open a plug-in GUI, hover your computer mouse over a control and turn the encoder for hands-on control.

*The sensitivity of **FOCUS** mode will vary depending on what plug-in or on-screen element you are controlling. You can use the mouse scroll sensitivity setting in your computer preferences to adjust to taste.*

Bank Keys

The **BANK < >** keys allow you to move tracks across your UF8 control surface(s) in multiples of 8, depending on how many UF8s are connected. e.g. 8 for one UF8, 16 for 2 UF8s etc.

Cursor Keys and Mode Key

In the lower-right corner of UF8 are the Cursor keys with the Zoom key in the centre.

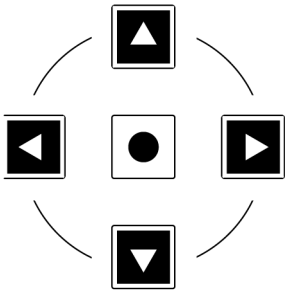

When the Zoom key is lit the cursor keys perform horizontal and vertical zooming.

Pressing the Zoom key again, the up and down and left and right cursor keys are used to navigate through parameter functions and pages in V-Pot assignment modes (Sends, Plug-ins etc).

The next page of this User Guide provides more information on using the cursor keys in conjunction with 'Channel View' and 'Mixer View' in Logic's Mackie Control implementation.

Automation

You can select the automation mode for each track directly from UF8. To do this, select a track you want to change the automation state of using the **SEL** key(s). Then, press the desired automation mode from the **AUTOMATION** keys in the lower-left corner of UF8.

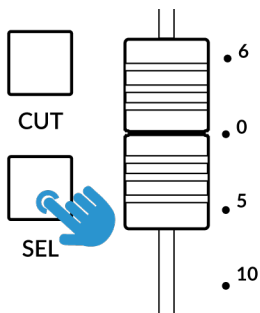

STEP 1: Select a track using SEL key

AUTOMATION

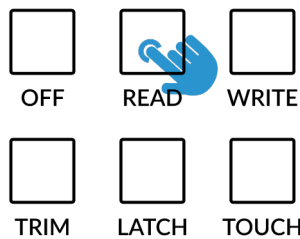

STEP 2: Select the desired automation state.

Tip: Hold the OPTION modifier (pre-assigned within SOFT KEY User Bank 3 as 'Opt') and then press one of the AUTOMATION keys to assign all tracks to a particular automation mode.

Quick Keys

The three **QUICK** keys located at the top-left of UF8 are user-assignable keys that are best used for access to your most frequent DAW commands or keyboard shortcuts. By default, they are assigned to the following commands but they can of course be changed in SSL 360°.

Default Quick Key Assignments:

- 1 - Show/hide Mixer within the Arrange window.
- 2 - Switch to 'AUX' view mode (one of the 'Global View' modes) - which shows only Aux tracks within the mixer.
- 3 - Global View Mode On/Off - Enters and exits 'Global View' Mode.

QUICK

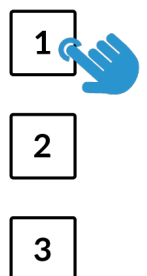

Fine

Press and hold the **FINE** key whilst turning a V-Pot that is controlling Send Levels for finer control. This key also functions as the **Cmd/Alt** modifier, allowing you to access secondary functions on many Mackie Control commands. Please refer to the Mackie Control section of the *Logic Pro Control Surfaces Support* User Guide for more info.

V-Pot Assignment Modes

UF8 offers direct access to the six main Mackie Control V-Pot assignment modes. These V-Pot assignment modes are accessed via the keys labelled below: 1. **PAN**, 2. **SEND**, 3. **INSTRUMENT**, 4. **EQ**, 5. **TRACK** and 6. **PLUGIN**. For an in-depth explanation of each V-Pot assignment mode, please refer to the Mackie Control section *Logic Pro Control Surface Support* document.

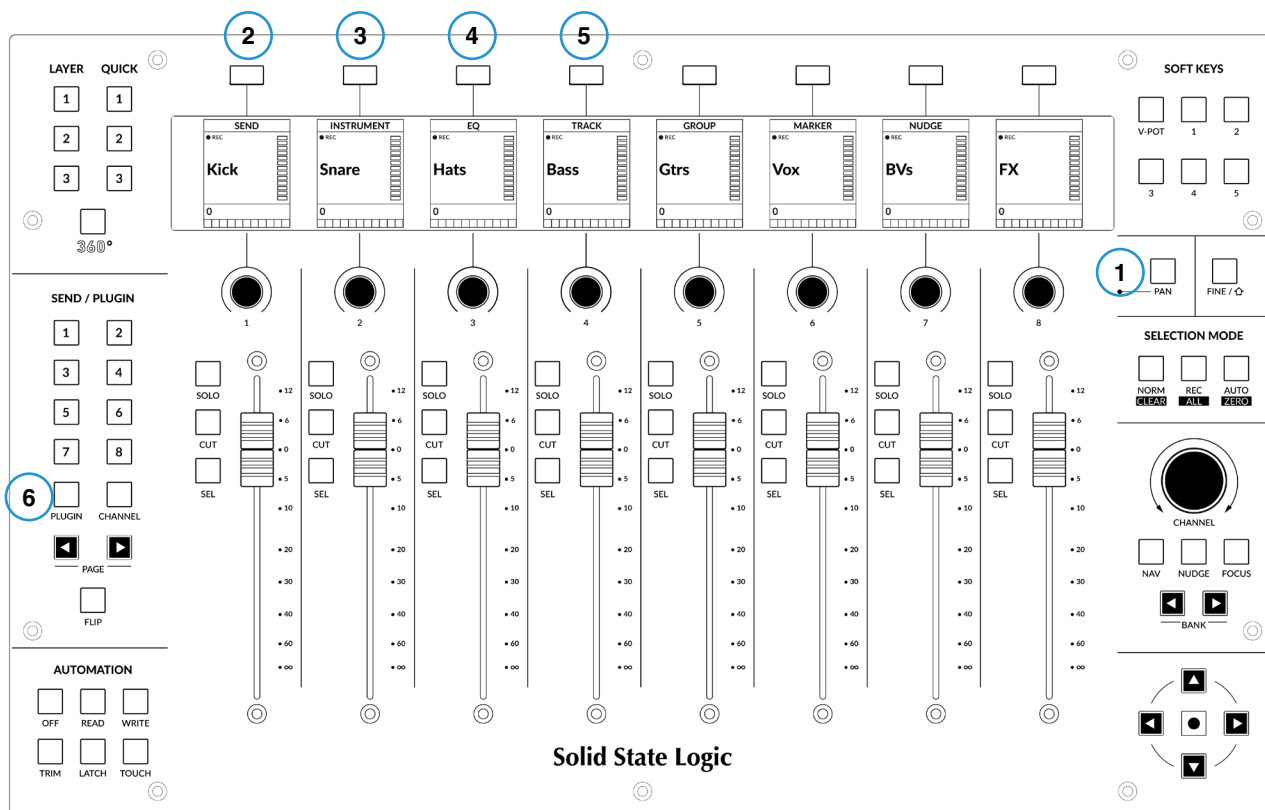

Channel View & Mixer View

Each V-Pot assignment mode can operate in two different ways - 'Channel View' or 'Mixer View'. Pressing the currently active V-Pot assignment key will toggle between the two view modes.

Let's take **SEND** mode as an example. The first time you press the **SEND** key, you will be put into 'Mixer View'. In this view, you can control one Send parameter (Destination/Level/Pan/Mute) for all tracks using the V-Pots. In 'Mixer View' the Left and Right cursor keys move between the next and previous parameter and the Up and Down cursor keys change the Send Slot selection e.g. Send 1, Send 2, Send 3 etc. Ensure the Zoom key is not active.

Pressing the **SEND** key again will toggle you into 'Channel View' which, by contrast, presents multiple Send parameters (Destination/Level/Pan/Mute) for the currently selected track across V-Pots. In 'Channel View', the Left and Right cursor keys will move between parameter pages and the Up and Down cursor keys will change the selected track (as long as the central Zoom key is not lit).

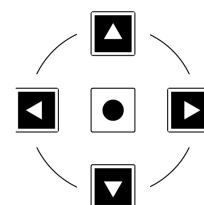

The cursor keys are integral to operating in Channel View and Mixer View.

Pressing and holding a V-Pot Assignment Key

Many of the V-Pot assignment keys have a press and hold feature. For example, press and hold the **SEND** key to display a sub-menu of options on the LCDs. In this particular example, 'Level' is presented above V-Pot 2, so pushing V-Pot 2 (whilst keeping **SEND** held down), assigns the V-Pots to control Send levels. This offers an alternative method of achieving the same task as using the cursor keys in 'Mixer View'.

Send / Plugin and Channel Key - How To Tell If You're In Channel View or Mixer View

The numbered keys in the **SEND / PLUGIN** section and the **CHANNEL** key are used to display if you are operating in 'Channel View' or 'Mixer View'. On a traditional Mackie Controller, this information would be displayed on the 2-digit Assignment, or 'Mode Display'.

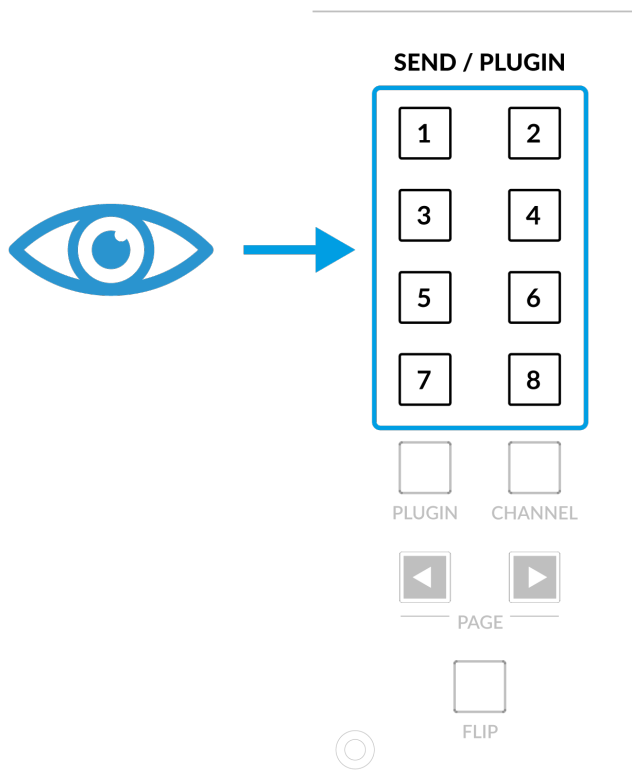

Mixer View

In 'Mixer View' the currently selected slot number (e.g. Send Slot or Plug-in Slot), will light the corresponding number key.

Channel View

In 'Channel View' the **CHANNEL** key will light.

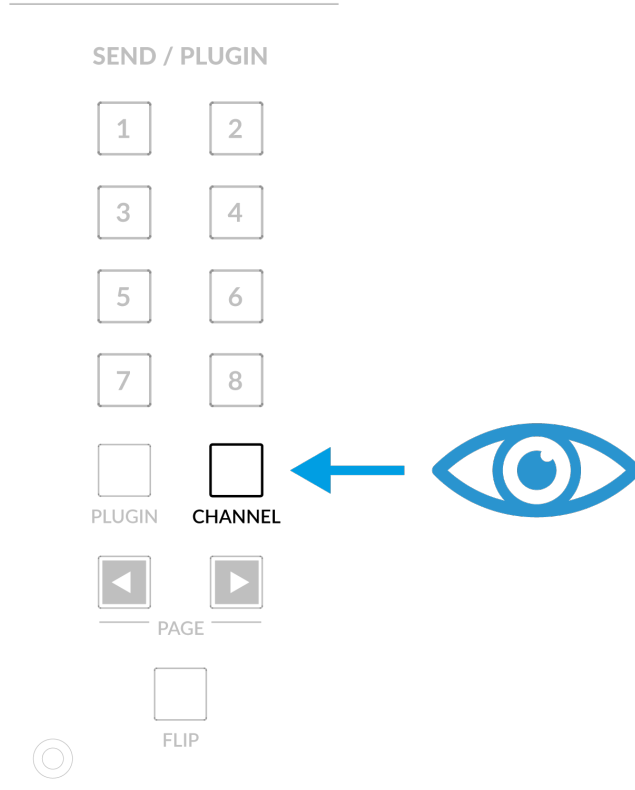

Page Keys

The **PAGE** < > keys offer no functionality in the Logic UF8 profile and are therefore disabled.



Flip

Pressing the **FLIP** key will engage or disengage one of Logic's three possible Flip modes - 'Flip', 'Swap' or 'Zero'. These are useful for various reasons, the most obvious 'Flip' feature allowing you to control V-Pot parameters such as Send levels or Plug-in parameters on the faders instead of the V-Pots. The Flip mode used is configured in the Mackie Control Surface Setup.



Group, Marker and Nudge

Soft Keys 5, 6 and 7 in the **V-POT** Soft Key bank allow access to Mackie Control 'Group', 'Marker' and 'Nudge' functions.

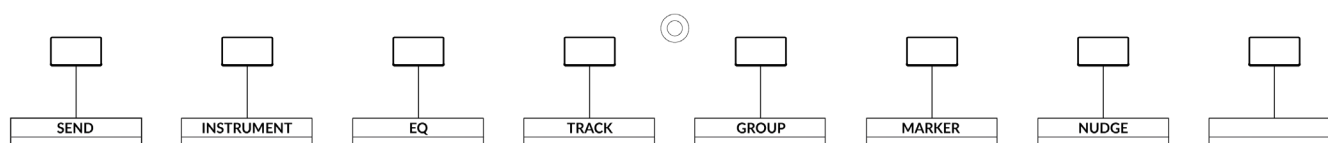

*For a detailed breakdown of exactly how **GROUP**, **MARKER**, **NUDGE** or any of the other Mackie Control commands operate, please refer to the Mackie Control section of the **Logic Pro Control Surface Support** document.*

User Bank Pre-Assignments

User Banks 1-5 allow you access to various DAW commands or keyboard shortcuts on the 8 soft keys along the top of UF8. These can of course be changed to any of the available DAW commands or your own keyboard shortcut sequences in the UF8 page of SSL 360°.

SOFT KEYS

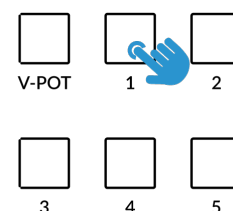

Select User Banks using Keys **1-5** in the **SOFT KEYS** section.

User Bank 1

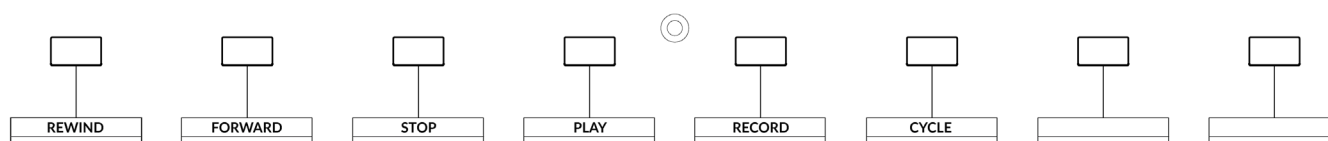

User Bank 2

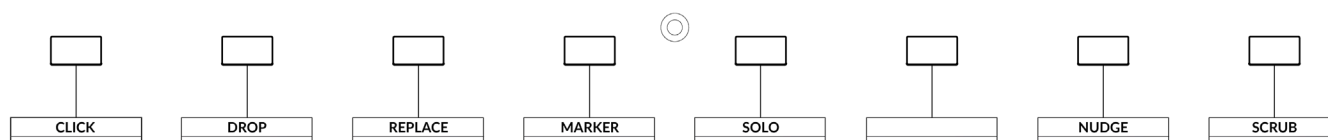

User Bank 3

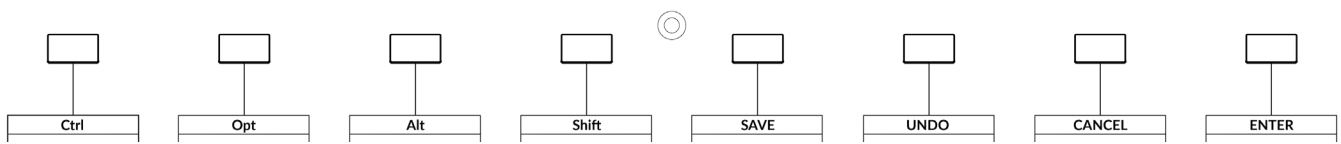

User Bank 4

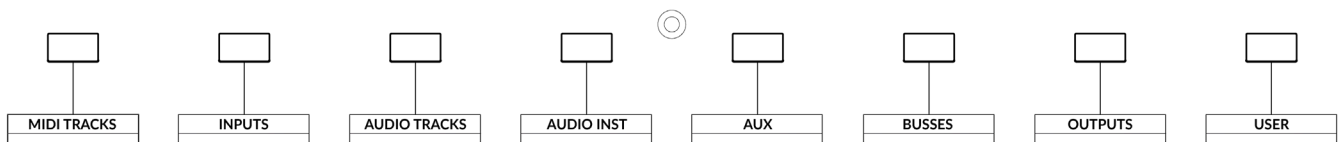

User Bank 5

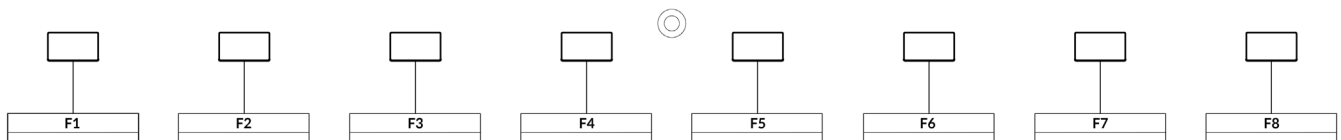

"Oh, tell me now, where was my fault, in loving you with my whole heart?" - White Blank Page, Mumford & Sons.

Assignable DAW Commands List - Logic

The following DAW commands are available in SSL 360° to assign to any of the User or Quick Keys.

Track	Solo
Pan/Surround	Forward
EQ	Rewind
Send	Stop
Plugin	Play
Instrument	Record
Flip	Scrub
Global	Play Foot-switch
Name/Value	Record Foot-switch
SMPTE/Beats	
F1	
F2	
F3	
F4	
F5	
F6	
F7	
F8	
MIDI Tracks	
Inputs	
Audio Tracks	
Audio Instruments	
Aux	
Busses	
Outputs	
User	
Shift	
Option	
Control	
Alt	
Read	
Write	
Touch	
Latch	
Trim	
Save	
Undo	
Group	
Cancel	
Enter	
Marker	
Nudge	
Cycle	
Drop	
Replace	
Click	

Cubase/Nuendo with UF8 - Tutorial

The following tutorial guides you through configuring and using the default Cubase/Nuendo profile on **LAYER 1** of UF8. If you wish to configure Cubase on a different layer, please refer to the *DAW Communication* section of this User Guide to ensure your DAW is configured for the correct **SSL V-MIDI** ports.

SSL 360° Setup

1. Open the SSL 360° application on your Mac or Windows computer and on the **HOME** page check that any UF8s you have connected are present - outline images of each UF8 appear on screen.
2. If you have multiple UF8s connected, click down on the outline image of each unit to check that the UF8s are arranged in the correct order. If units need to be re-ordered then click and drag to re-arrange.
3. Go to the **UF8** page and set **Layer 1** to **Cubase** using the drop-down list.

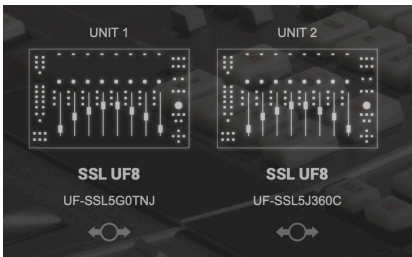

STEP 1 : Open SSL 360° application. Connected UF8s appear on-screen.

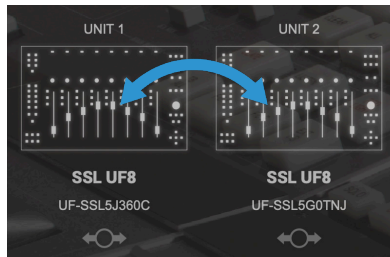

STEP 2 : Click and drag to re-order units if necessary.

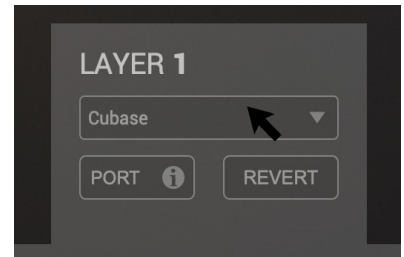

STEP 3 : Select the default Cubase DAW profile from the UF8 page.

Cubase Setup

4. Open Cubase. Go to **Studio > Studio Setup...**
5. Click the **+** symbol in the top-left of the window and select **Mackie Control** from the drop-down list. Set the **MIDI Input** to **SSL V-MIDI Port 1 Source** and set **MIDI Output** to **SSL V-MIDI Port 1 Destination**. Click **Apply**. If you only have one UF8, skip to step 10.
6. If you have multiple UF8s, repeat step 5 - adding another **Mackie Control** and incrementing the **SSL V-MIDI** Port number for the **MIDI Input** and **MIDI Output** each time - e.g. the second UF8 would be set to **SSL V-MIDI Port 2**.

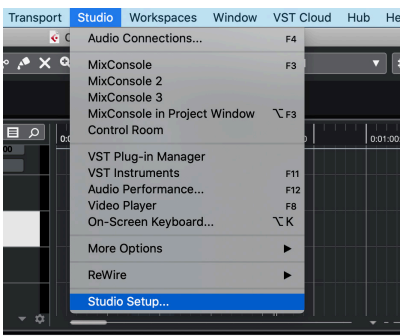

STEP 4 : Open the Studio > Studio Setup... menu in Cubase.

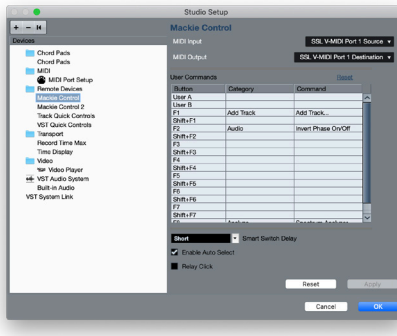

STEP 5 : Add a Mackie Control and configure MIDI Input and MIDI Output to SSL V-MIDI Port 1. Click Apply.

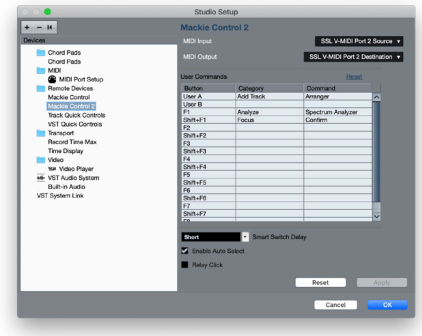

STEP 6 : If you have multiple UF8s, add more Mackie Control units and increment SSL V-MIDI Port number.

If you have multiple UF8s and have followed Steps 1-6 you will notice that, even though you have configured multiple Mackie Controllers on different **SSL V-MIDI Ports** and clicked **Apply**, the UF8s in front of you are mirroring the same bank of tracks. This is due to a peculiarity of Cubase's Mackie Control Setup. To correct this, please now do the following:

7. Change **MIDI Input** and **MIDI Output** on the first **Mackie Control** to **SSL V-MIDI Port 2** and click **Apply**.
8. Change the **MIDI Input** and **MIDI Output** on the second **Mackie Control** to **SSL V-MIDI Port 1** and click **Apply**.
9. To make Cubase refresh the LCDs on UF8, press any of the Soft Keys in the **V-POT** bank such as **FX Send** or **EQ**.

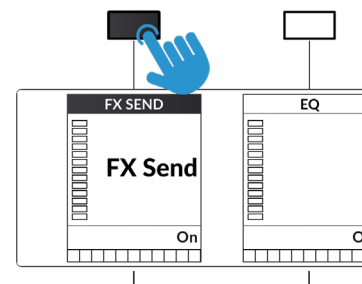
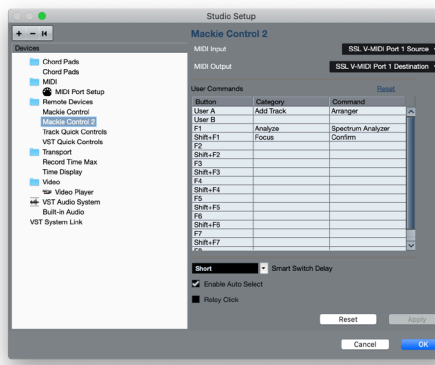
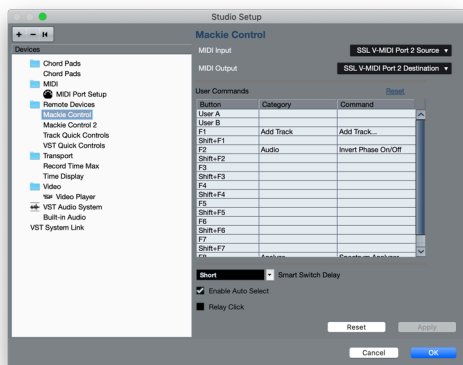

STEP 7 : Select the first Mackie Control and change it to be configured for SSL V-MIDI Port 2.

STEP 8 : Select Mackie Control 2 and change it to be configured for SSL V-MIDI Port 1.

STEP 9 : Force Cubase to update UF8's LCD Screens by changing V-POT assignment mode on UF8 e.g. press FX SEND.

10. Next, go to **Studio > More Options** and click on **Mackie Control** and **Mackie Control 2**, ensuring both small pop-up windows that appear have **Cubase** selected, instead of **Compatibility**. This is important as UF8 has been designed to work with Steinberg's latest implementation of the Mackie Control Protocol and must be in **Cubase** mode to ensure all features work as expected.

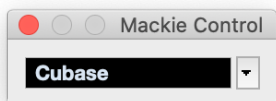

STEP 10 : Ensure that the Mackie Controls are configured for 'Cubase' mode, via the drop-down available in the 'Studio' > 'More Options' menu.

11. As a final step, go to **Studio Setup > MIDI Port Setup** and deactivate the **In 'ALL MIDI Inputs'** option for your **SSL V-MIDI Ports** and click **OK**. This will ensure that MIDI Instrument Tracks set to receive from **ALL MIDI Inputs** do not pickup MIDI data from UF8.

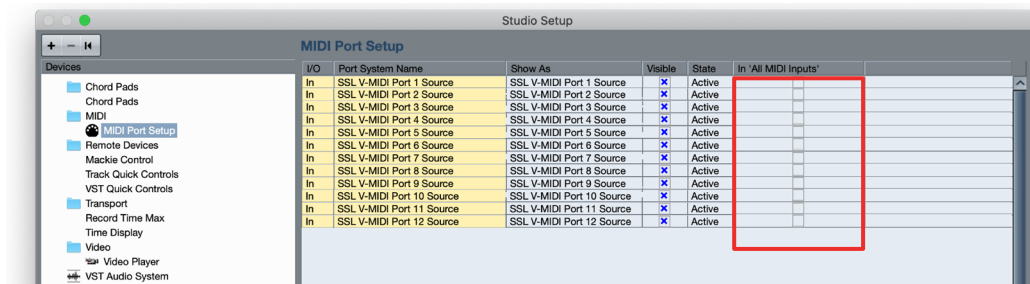

STEP 11 : Disable In 'ALL MIDI Inputs' for SSL V-MIDI Ports

LCD Layout

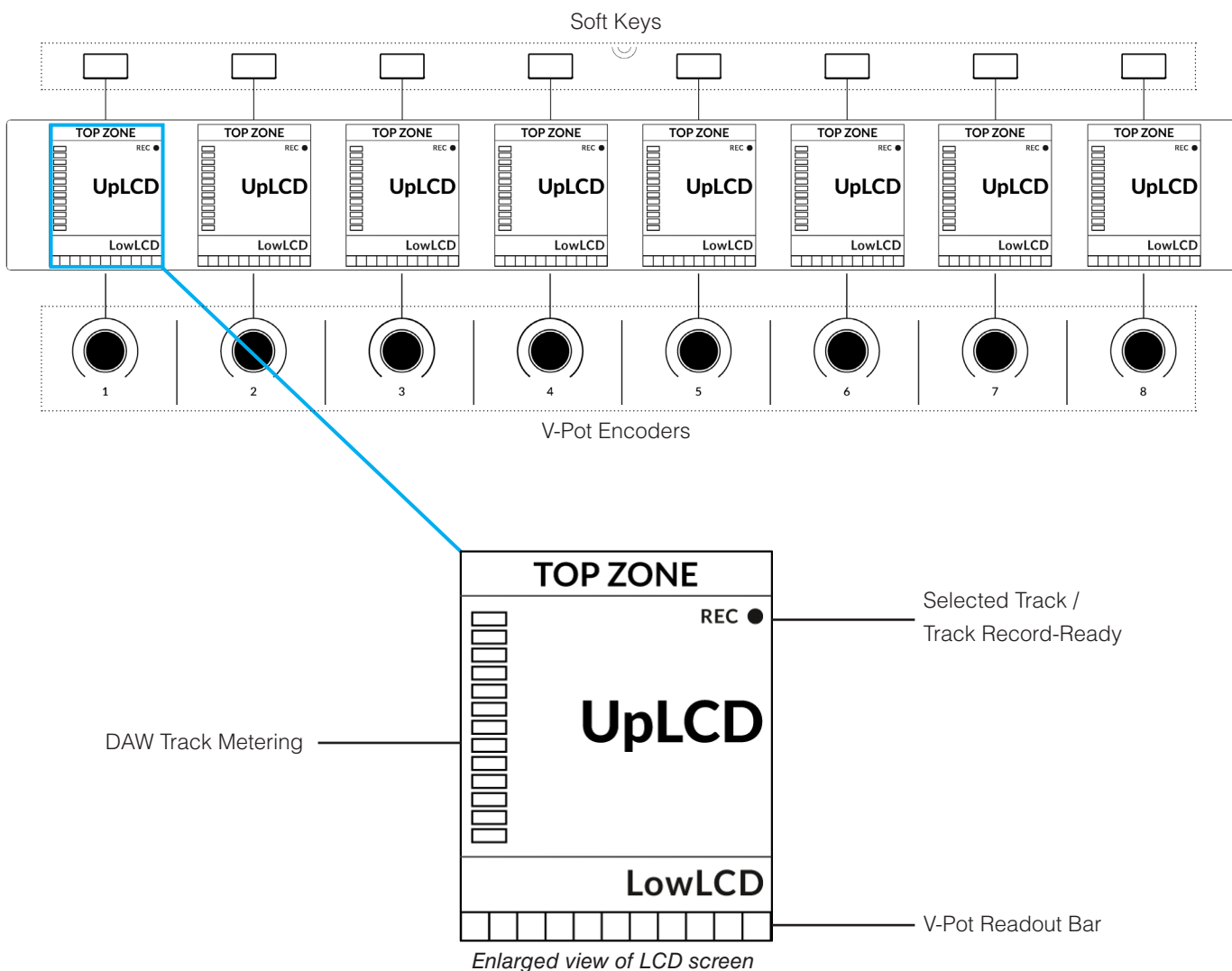

Top Zone - Provides a label for the function assigned to the soft key button directly above.

Selected Track / Track Record-Enabled (REC) - In Cubase, the **REC** text follows the currently selected track and also indicates the track is Record-Ready.

UpLCD - Displays the 6-character track name or information regarding the current V-Pot assignment, depending on the current mode.

LowLCD - Displays name or value information for the V-Pots, depending on which mode or page is selected.

DAW Track Metering - 12-segment track metering + clip

V-Pot Readout Bar - Displays the position of the currently assigned V-Pot (encoder) function.

Tutorial

This section guides you through using UF8 with Cubase.

Before You Start...

The information in this Cubase Tutorial sets out the key features of using UF8 with Cubase.

For complete, in-depth coverage of all the functions and features you can control in Cubase using UF8, please refer to the Mackie MCU Pro section of Steinberg's *Remote Control Devices* PDF document, available via the Cubase/Nuendo Help menu.

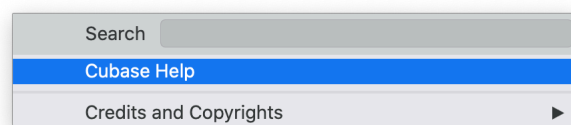

The Cubase Help menu can be used to find the link to the 'Remote Control Devices' document shown below

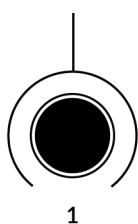
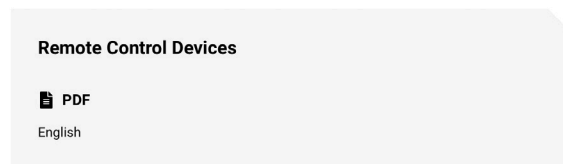

1

V-Pot

At the top of each strip is the V-Pot (virtual pot). The function of the V-Pot varies, depending on which V-Pot assignment mode is currently active (Pan, FX Send etc) but is typically used for tasks such as controlling pan position, send levels, plug-in parameters or scrolling through parameter options/lists.

The V-Pot has a push function, which by default operates the track Monitor function when the V-Pot assignment mode is Pan.

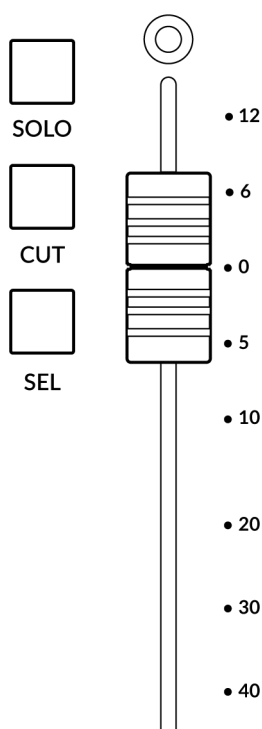

100 mm Motorised Fader

Motorised, touch-sensitive faders provide physical control of your Cubase tracks and are great for balancing mix levels and writing automation.

Solo, Cut & Sel (Select)

Each strip contains **SOLO**, **CUT** and **SEL** keys corresponding to the solo, mute and select features for each track in Cubase.

Tip:

The Solo Defeat MCU function (pre-assigned to Quick Key 3) can be used to clear all solos.

Pressing and hold the MCU Shift function (the **FINE / SHIFT** key) and pressing Solo Defeat (Quick Key 3) can be used to clear all mutes.

Selection Mode

The primary purpose of the **NORM** and **REC** keys in the **SELECTION MODE** section is to determine the behaviour of the **SEL** keys.

NORM - The **SEL** keys select a track in Cubase.

REC - The **SEL** keys record-arm multiple tracks.

AUTO - Disabled. This key only applies for Pro Tools profiles.

SELECTION MODE

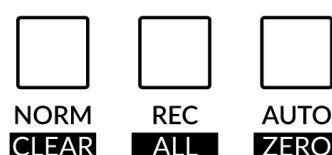

You will notice that there are additional labels beneath the **SELECTION MODE** keys. These functions have no purpose in the Cubase UF8 profile.

Channel Encoder

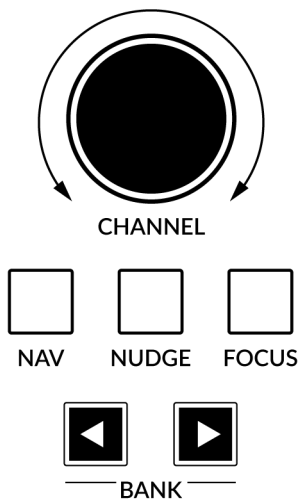

By default, the **CHANNEL** encoder is used to move your DAW tracks across the UF8 surface, in increments of 1 channel at a time. If you find yourself in **NAV** or **FOCUS** modes, simply push the **CHANNEL** encoder to return to **CHANNEL** mode.

Nav

Pressing the **NAV** key changes the **CHANNEL** encoder to operate the playhead position in Cubase, allowing you to navigate through your session.

Nudge

Disabled. Only applies to Pro Tools profiles.

Focus

Pressing the **FOCUS** key puts the **CHANNEL** encoder into Focus mode, which emulates the scroll function of a mouse. This can be a really nice way of controlling plug-ins or anything else on screen that responds to a mouse scroll operation. Simply open a plug-in GUI, hover your computer mouse

over a control and turn the encoder for hands-on control.

The sensitivity of FOCUS mode will vary depending on what plug-in or on-screen element you are controlling. You can use the mouse scroll sensitivity setting in your computer preferences to adjust to taste.

Bank Keys

The **BANK < >** keys allow you to move tracks across your UF8 control surface(s) in multiples of 8, depending on how many UF8s are connected. e.g. 8 for one UF8, 16 for 2 UF8s etc.

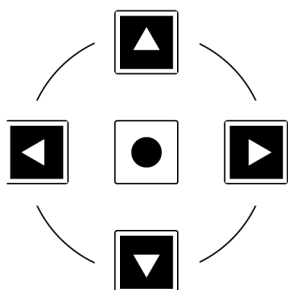

Cursor Keys and Mode Key

In the lower-right corner of UF8 are the Cursor keys with the Zoom key in the centre.

When the Zoom key is lit the cursor keys perform horizontal and vertical zooming.

Pressing the Zoom key again, the cursor keys mirror the actions of the cursor keys on your computer keyboard in Cubase.

Automation

You can select the automation mode for each track directly from UF8. To do this, select a track you want to change the automation mode of using the **SEL** key. Then, press the desired automation mode from the **AUTOMATION** keys in the lower-left corner of UF8. Press **READ** or **WRITE** again to toggle on/off.

Note that **READ** and **WRITE** are the only automation keys that apply to Cubase, so all other keys in this section are disabled when using Cubase.

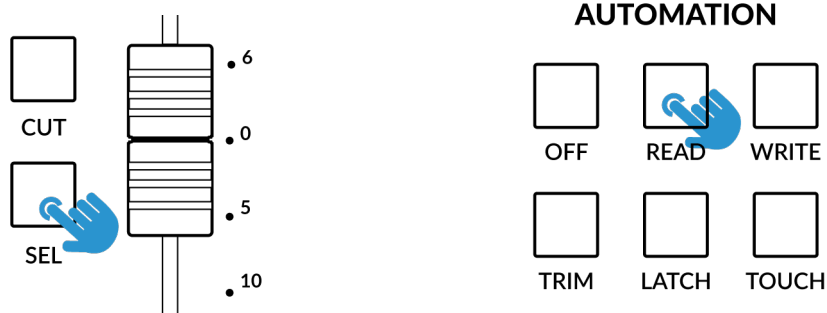

STEP 1: Select a track using SEL key

STEP 2: Select the desired automation state.

Quick Keys

The three **QUICK** keys located at the top-left of UF8 are user-assignable keys that are best used for access to your most frequent DAW commands or keyboard shortcuts. By default, they are assigned to the following commands but they can of course be changed in SSL 360°.

Default Quick Key Assignments:

- 1 - Show/hide Mix Console Window.
- 2 - Show/hide Edit Window.
- 3 - Solo Defeat - clears any solos.

QUICK



Fine / Shift Key

The key labelled **FINE / SHIFT** is programmed to execute Cubase's MCU **SHIFT** command (ignore the 'FINE' text). This command, when used in combination with other MCU functions or V-Pot assignment modes, provides access to alternative/additional functionality.

Please refer to the **Mackie MCU Pro** section of the **Cubase Remote Control Devices** PDF for more information.

Page Keys

The **PAGE** <> keys allow you to move through the various parameter pages that are available within each V-Pot assignment mode (or 'Parameter Group' as Cubase refers to them). The current page selection is displayed on UF8's LCDs.



Important

UF8's **PAGE** <> are actioning the same MCU commands that are referred to in Cubase's MCU implementation document as **CHANNEL** <>. The action is the same but on UF8, we chose to label the keys differently.

Flip

Pressing the **FLIP** key switches the functions of the V-Pots and faders. This is useful for various reasons, including tasks such as controlling Send levels or Plugin parameters on the faders instead of the V-Pots.



Fader Bank Keys

Number keys **1-8** provide access to Cubase's MCU Fader Bank 1-8 commands (you can ignore the **SEND / PLUGIN** label as this applies only to Pro Tools / Logic UF8 profiles).

By default, this means that keys **1-8** apply your first 8 Channel Visibility settings to the UF8 surface.

With the **FINE / SHIFT** key held, keys **1-8** apply specific channel types (Audio, Groups, FX Channels, MIDI etc) to the UF8 surface.

Please reference **Cubase Remote Control Devices** documentation for more information.

SEND / PLUGIN

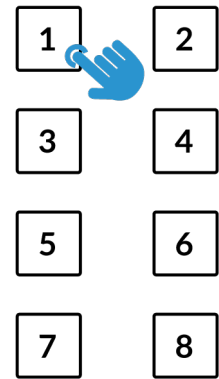

Channel Key



CHANNEL

This key serves no purpose for Cubase profiles on UF8 and is therefore disabled.

V-Pot Assignment Modes

UF8 offers direct access to the main modes of Cubase's Mackie Control implementation. For an in-depth explanation of how to use each V-Pot assignment mode, please refer to the **Mackie MCU Pro** section of Steinberg's **Remote Control Devices** document.

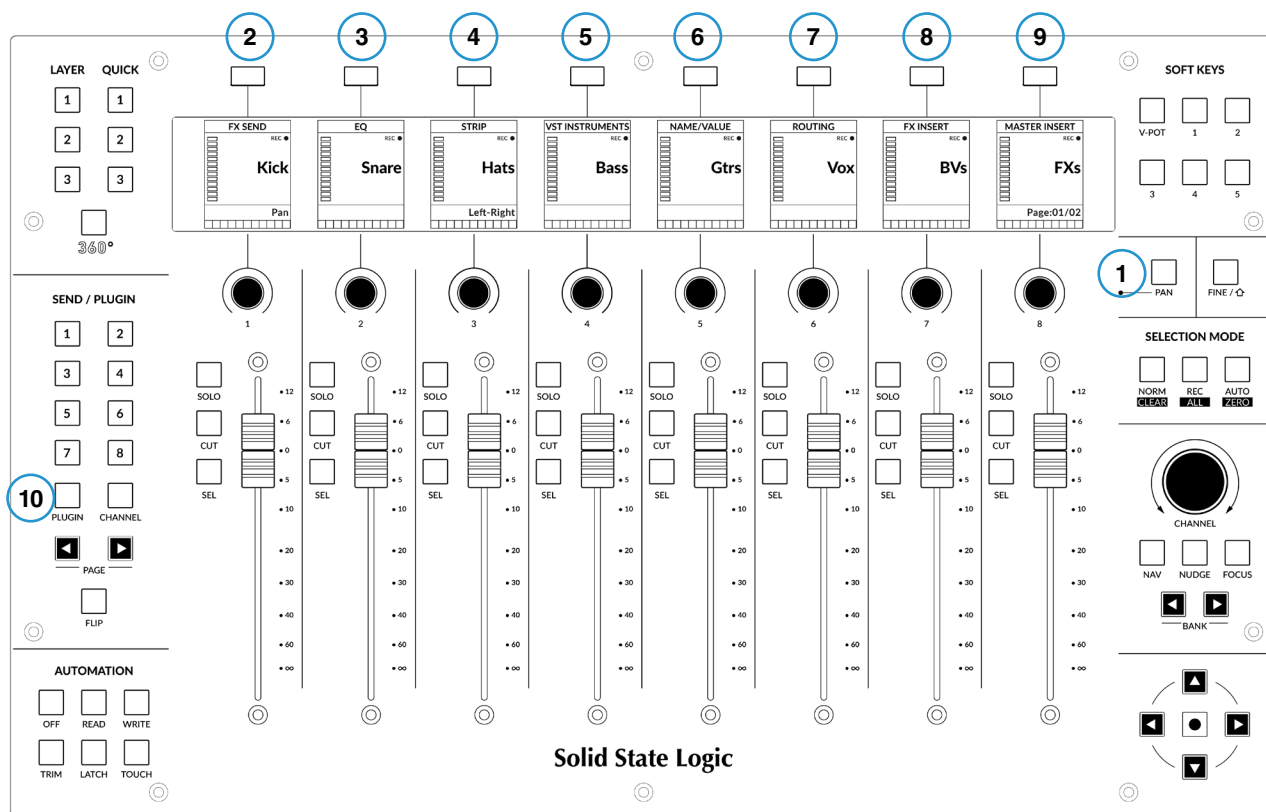

Nomenclature Table

The column 'Cubase/Nuendo MCU Function', contains the MCU function names as referred to in Steinberg's **Remote Control Devices** documentation. These names are taken from the Cubase/Nuendo overlays that are placed onto a Mackie Controller (replacing the default Logic labels). The Cubase MCU implementation has evolved over the years and as such, some of the labels don't quite match the functionality, so we have presented the most intuitive labels possible on UF8 to make operation easier. For example the 'FIRST' key on a Mackie Control with a Cubase overlay accesses controls for routing so we have labelled our key **ROUTING** instead.

Mode	Cubase/Nuendo MCU Function	UF8 Label
1	PAN	PAN
2	LAST	FX SEND
3	EQ	EQ
4	DYN/FX/AUX	STRIP
5	INSTRUMENT	VST INSTRUMENTS
6	NAME/VALUE	NAME/VALUE
7	FIRST	ROUTING
8	SENDS	FX INSERT
9	MASTER	MASTER INSERT
10	PLUGINS	PLUGIN

Name/Value

Strictly speaking, the **NAME/VALUE** function is not a V-Pot assignment mode by itself but it does have the useful function of displaying parameter values on the LCD screens. Without engaging this, parameter values are shown when a V-Pot is turned.

Example - Controlling Sends

It is beyond the scope of this User Guide to cover all of the different V-Pot assignment modes within the Cubase MCU implementation, however an example of controlling Sends is presented below.

Send Settings - Selected Channel

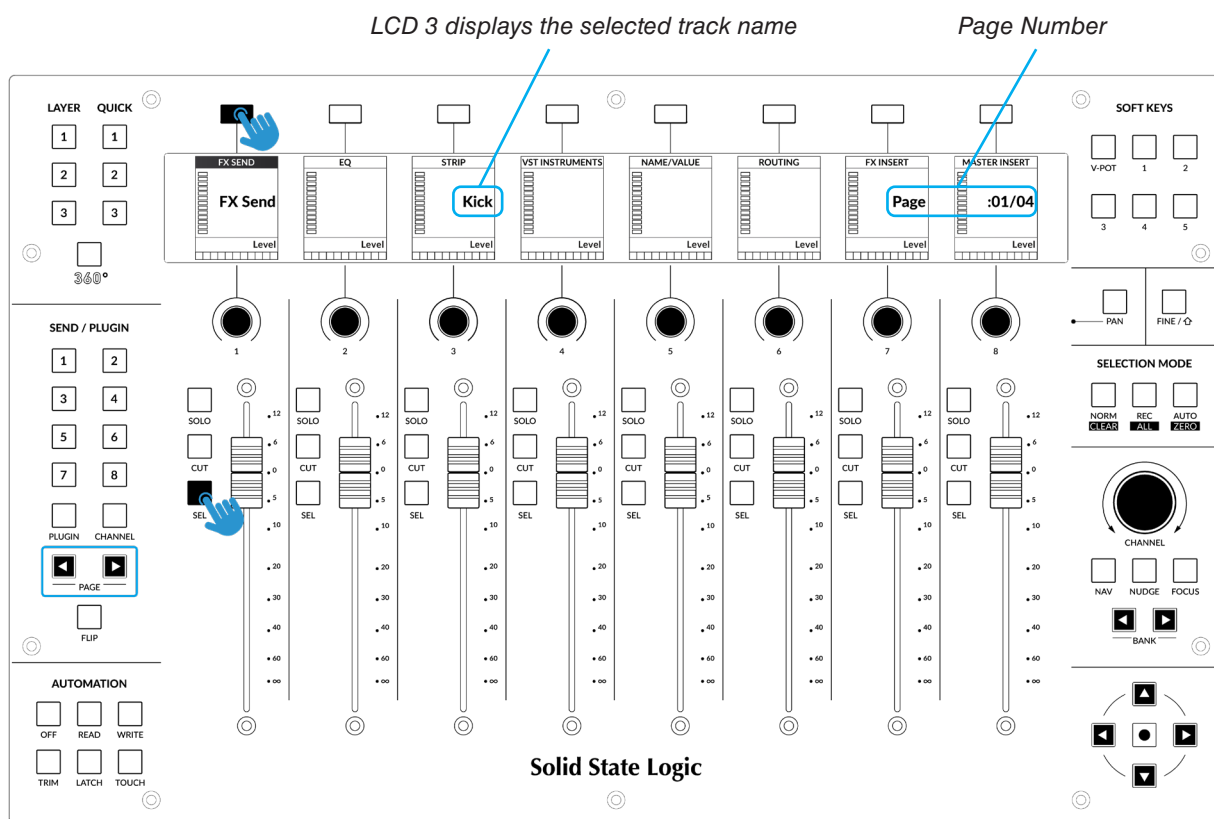

- Press the **FX SEND** key. This mode allows you to control all the Send parameters for the currently selected track using the V-Pots - e.g. all the Send levels on the selected track.
- Use the **PAGE** keys to move between parameter pages.

Send Settings - Global

Alternatively, Global mode provides you with access to the advanced send settings for the tracks currently on the UF8 surface. For example, you can control a send parameter (e.g. level), of FX Send 1 across multiple tracks at once using the V-Pots.

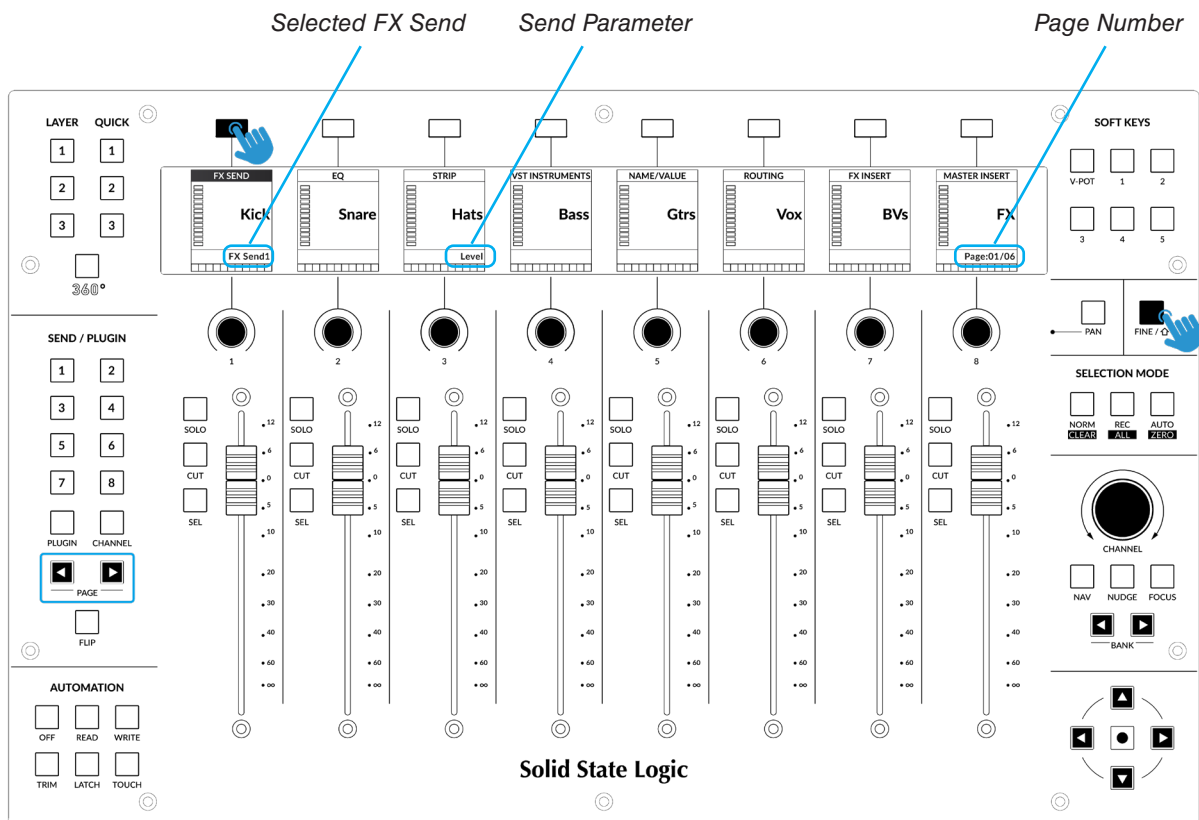

- This is an example of a V-Pot assignment mode that is accessed by pressing and holding the SHIFT MCU Command (the key labelled **FINE/SHIFT** on UF8).
- Press and hold the **FINE/SHIFT** key and then press the **FX SEND** key. This will select FX Send 1 but you can move through the rest of the FX Sends by continuing to keep **FINE/SHIFT** held and repeatedly pressing the **FX SEND** key
- Use the **PAGE** keys to move between parameter pages.

Each V-Pot assignment mode may vary slightly in terms of how it operates so it's important to refer to the Mackie MCU Pro section of Steinberg's Remote Control Devices PDF for more information.

User Bank Pre-Assignments

User Banks 1-5 allow you access to various DAW commands or keyboard shortcuts on the 8 soft keys along the top of UF8. These can of course be changed to any of the available DAW commands or your own keyboard shortcut sequences in the UF8 page of SSL 360°.

Select User Banks using Keys 1-5 in the **SOFT KEYS** section.

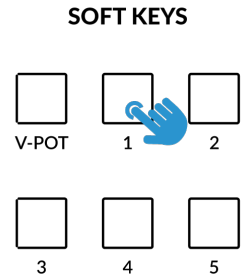

User Bank 1

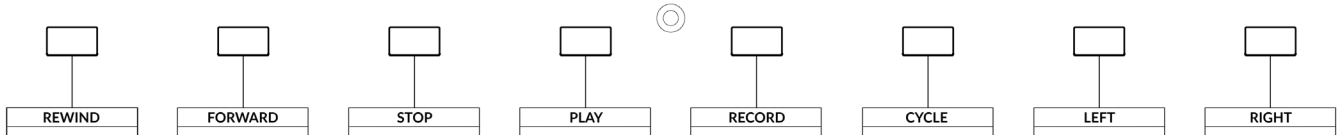

User Bank 2

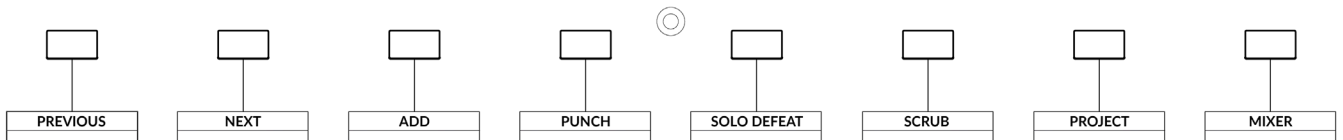

User Bank 3

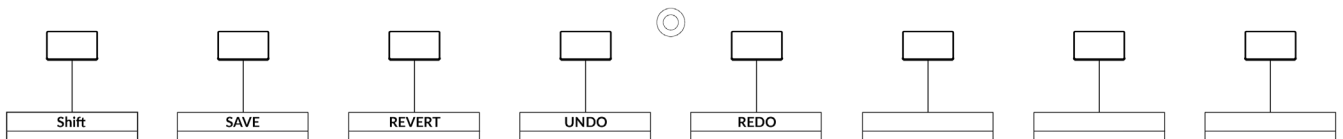

User Bank 4

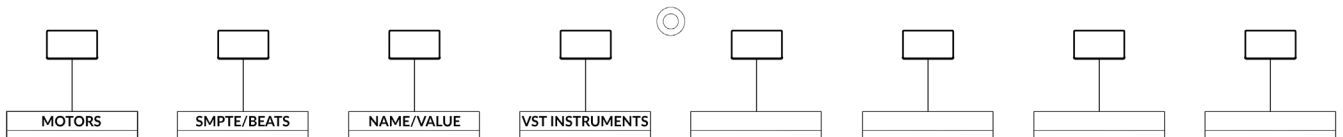

User Bank 5

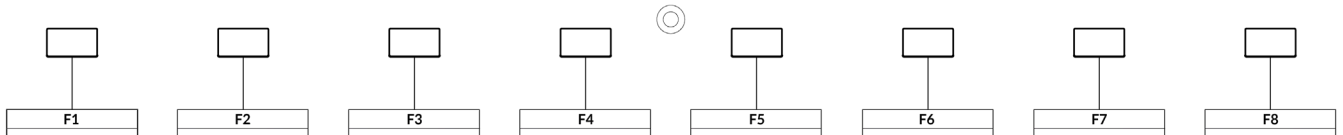

Function Select Keys 1-8 (F1 - F8)

In the **Studio Setup...** menu within Cubase, where the Mackie Control ports are configured during setup, you can program the **F1 - F8** keys found in User Bank 5 to any of the extensive list of Cubase commands made available in the **User Commands** table - choose a category and then a command from that category. Each **F** key can be shifted using the **FINE/SHIFT** key, giving you a total of 16 user commands plus the optional 'User A' and 'User B' foot pedals.

Assignable DAW Commands List - Cubase/Nuendo

The following DAW commands are available in SSL 360° to assign to any of the User or Quick Keys. Labels in brackets are added to clarify what the function does.

First (Routing)	Add
Pan	Next
EQ	Forward
Last (FX Sends)	Rewind
Plugins (IFX Inserts)	Stop
Dyn/FX/Aux (Strip)	Play
Flip	Record
Edit (Window)	Scrub
Name/Value	User A
SMPTE/Beats	User B
F1	
F2	
F3	
F4	
F5	
F6	
F7	
F8	
Fader Bank 1	
Fader Bank 2	
Fader Bank 3	
Fader Bank 4	
Fader Bank 5	
Fader Bank 6	
Fader Bank 7	
Fader Bank 8	
Undo	
Redo	
Save	
Revert	
Read	
Write	
Project	
Mixer	
Sends (FX IFX 1st Insert)	
Instruments (VSTs)	
Master (Insert)	
Motors	
Solo Defeat	
Shift	
Left	
Right	
Cycle	
Punch	
Previous	

Ableton Live with UF8 - Tutorial

The following tutorial guides you through configuring and using the default Live profile on LAYER 1 of UF8. If you wish to configure Live on a different layer, please refer to the *DAW Communication* section of this User Guide to ensure your DAW is configured for the correct **SSL V-MIDI** ports.

SSL 360° Setup

1. Open the SSL 360° application on your Mac or Windows computer and on the **HOME** page check that any UF8s you have connected are present - outline images of each UF8 appear on screen.
2. If you have multiple UF8s connected, click down on the outline image of each unit to check that the UF8s are arranged in the correct order. If units need to be re-ordered then click and drag to re-arrange.
3. Go to the **UF8** page and set **Layer 1** to **Ableton Live** using the drop-down list.

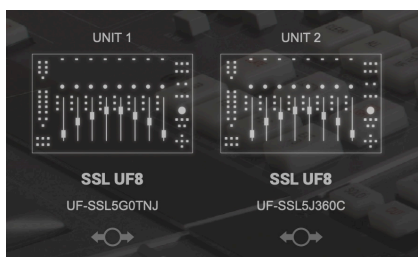

STEP 1 : Open SSL 360° applicaton. Connected UF8s appear on-screen.

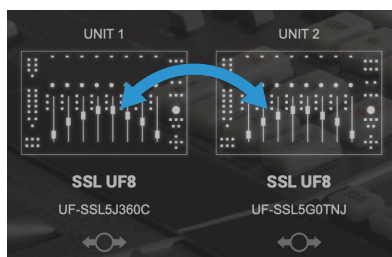

STEP 2 : Click and drag to re-order units if necessary.

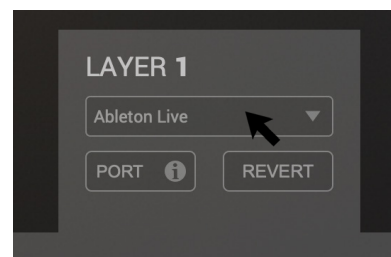

STEP 3 : Select the default Ableton Live DAW profile from the UF8 page.

Live Setup

4. Open Live. Go to **Preferences > Link MIDI...**
5. From the **Control Surface** drop-down list select **MackieControl**. Set the **Input** to **SSL V-MIDI Port 1 Source** and set **Output** to **SSL V-MIDI Port 1 Destination**.
6. If you have multiple UF8s, use drop-down lists 2-4 to add subsequent **MackieControl XT**s, incrementing the SSL V-MIDI Port number for the **Input** and **Output** each time - e.g. the second UF8 would be set to **SSL V-MIDI Port 2**.



STEP 4 : Go the Preferences menu and click on the Link MIDI tab.

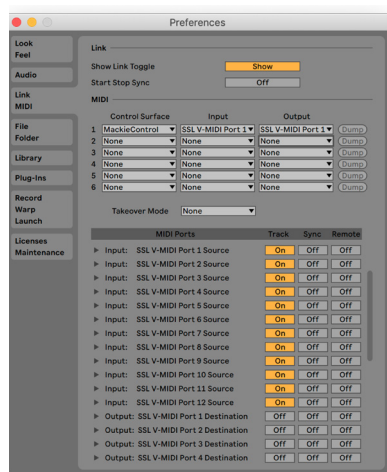

STEP 5 : Add a MackieControl and configure for SSL V-MIDI Port 1 on Input and Output

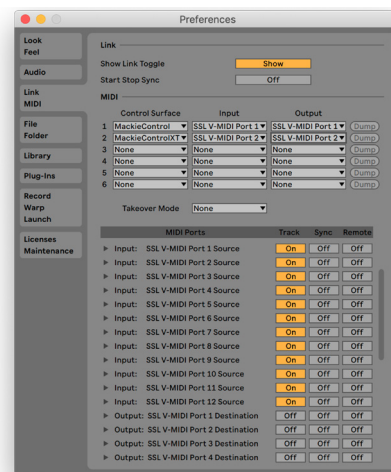

STEP 6 : If you have multiple UF8s, add MackieControl XT units and increment SSL V-MIDI Port number each time.

LCD Layout

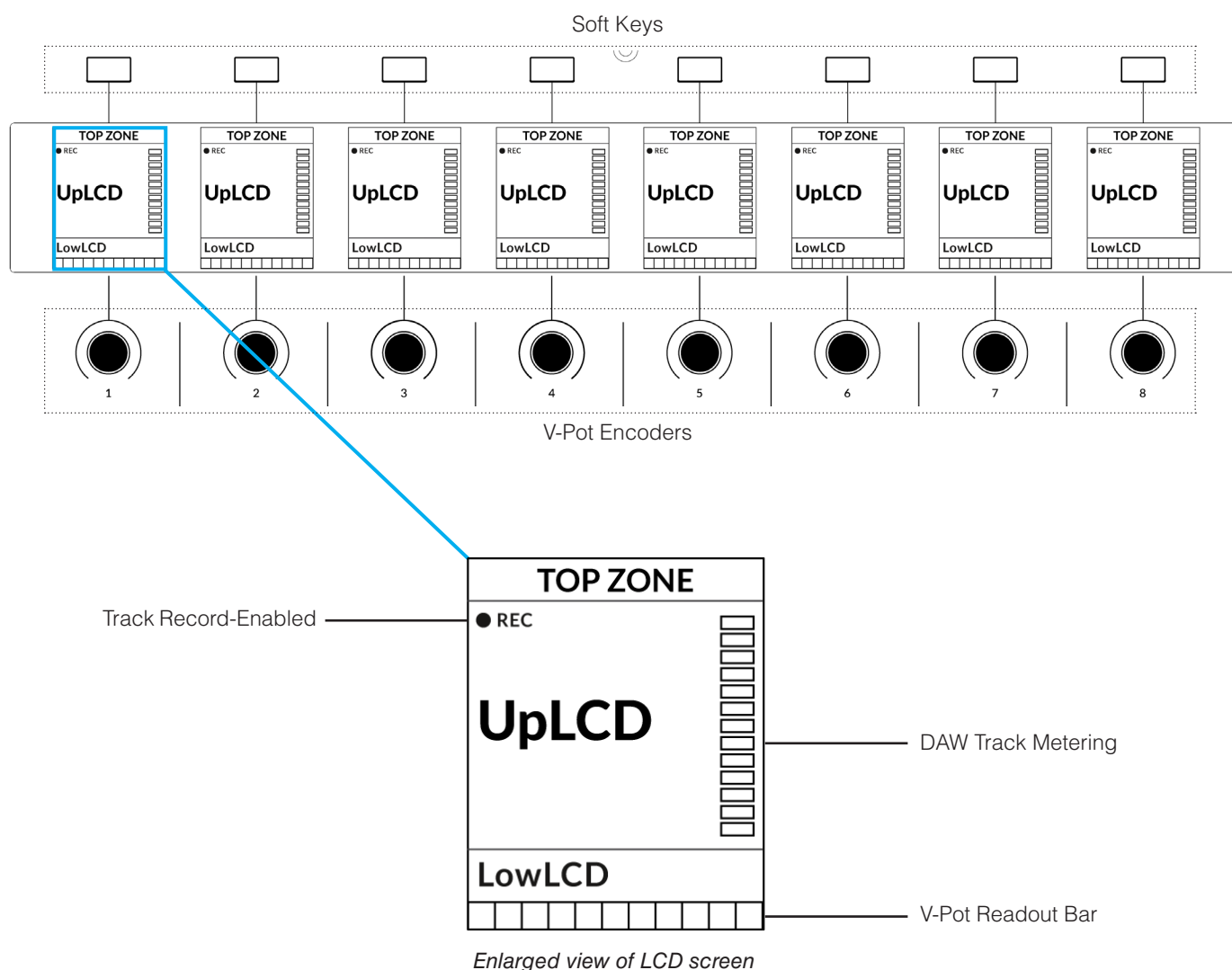

Top Zone - Provides a label for the function assigned to the Soft Key button directly above.

Track Record-Enabled (REC) - In Live, the **REC** text appears when a track is record-enabled.

UpLCD - Normally displays the 6-character track name or parameter being controlled by the V-Pot, depending on the current mode. When a fader is moved the word 'Volume' appears here.

LowLCD - Displays a label or value readout for the parameter currently assigned to the V-Pot, unless a fader is moved, in which case the fader dB value is shown.

DAW Track Metering - 12-segment track metering + clip

V-POT readout bar - Displays the position of the currently assigned V-Pot (encoder) function.

Tutorial

This section guides you through using UF8 with Live.

V-Pot

At the top of each strip is the V-Pot (virtual pot). The function of the V-Pot varies, depending on which V-Pot assignment mode is currently active (Pan, Send etc) but is typically used for tasks such as controlling Pan position, Send levels, Plug-in parameters or scrolling through parameter options/lists.

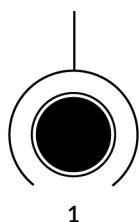

The V-Pot has a push function, which is typically used for defaulting the position of the parameter being controlled.

100 mm Motorised Fader

Motorised, touch-sensitive faders provide physical control of your Live tracks and are great for balancing mix levels and writing automation.

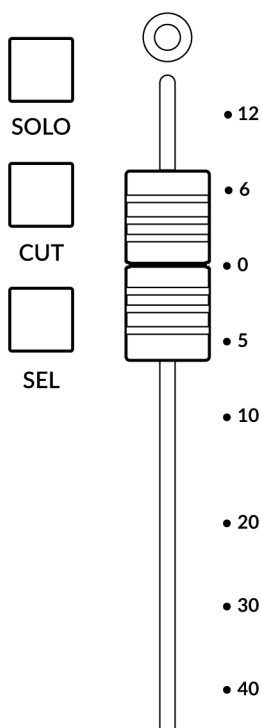

Touching a single fader will cause the LowLCD area to display a fader dB readout, instead of the V-Pot parameter readout.

Solo, Cut & Sel (Select)

Each strip contains **SOLO**, **CUT** and **SEL** keys corresponding to the solo, mute and select features for each track in Live.

Selection Mode

The primary purpose of the **NORM** and **REC** keys in the **SELECTION MODE** section is to determine the behaviour of the **SEL** keys.

NORM - The **SEL** keys select a track in Live.

REC - The **SEL** keys act as record-arm keys.

AUTO - Disabled. This key only applies for Pro Tools profiles.

The secondary labels **CLEAR**, **ALL** and **ZERO** do not apply for Live's UF8 integration.

SELECTION MODE

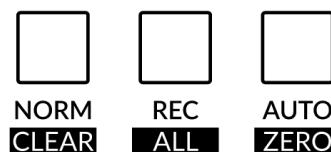

Channel Encoder

By default, the **CHANNEL** encoder is used to move your DAW tracks across the UF8 surface, in increments of 1 channel at a time. If you find yourself in **NAV** or **FOCUS** modes, simply push the **CHANNEL** encoder to return to **CHANNEL** mode.

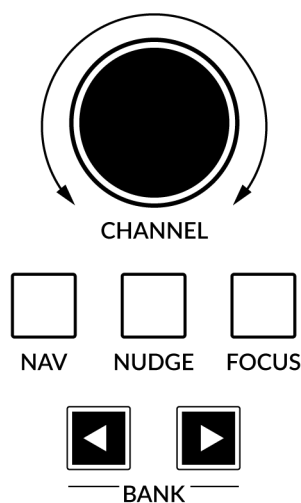

Nav

Pressing the **NAV** key changes the **CHANNEL** encoder to operate the playhead position in Live, allowing you to navigate through your session.

Nudge

Disabled. Only applies to Pro Tools profiles.

Focus

Pressing the **FOCUS** key puts the **CHANNEL** encoder into Focus mode, which emulates the scroll function of a mouse. This can be a really nice way of controlling plug-ins or anything else on screen that responds to a mouse scroll operation. Simply open a plug-in GUI, hover your computer mouse over a control and turn the encoder for hands-on control.

The sensitivity of FOCUS mode will vary depending on what plug-in or on-screen element you are controlling. You can use the mouse scroll sensitivity setting in your computer preferences to adjust to taste.

Bank Keys

The **BANK < >** keys allow you to move tracks across your UF8 control surface(s) in multiples of 8, depending on how many UF8s are connected.

Cursor Keys and Mode Key (Launching Clips and Zooming)

In the lower-right corner of UF8 are the Cursor keys with the Mode key in the centre. The function of these keys depends on the current view in Live.

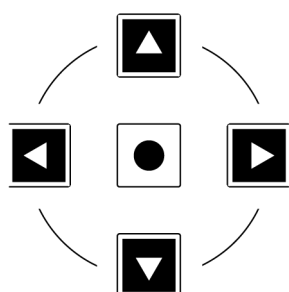

Session View

When working in Session View, the cursor keys allow you to navigate up, down, left and right to highlight the clip you want to launch and the Mode key in the middle allows you to launch clips.

Arrangement View

When the Mode key is lit the left and right cursor keys perform horizontal zooming in/out and the up and down cursor keys increase/decrease the track height of the currently selected track.

Pressing the Mode key again, the up and down cursor keys change the selected track and the left and right cursor keys move the cursor left/right.

Launch Scenes (Use the FINE / SHIFT key)



The key labelled **FINE / SHIFT** is programmed to execute the Launch Scene function in Live. Simply use the cursor keys to navigate to the scene you want and press the **FINE / SHIFT** key to launch the scene.

Automation

The **AUTOMATION** keys in the bottom-left of UF8 do not apply for Live and are therefore disabled.

Quick Keys

The three **QUICK** keys located at the top-left of UF8 are user-assignable keys that are best used for access to your most frequent DAW commands or keyboard shortcuts. By default, they are assigned to the following commands but they can of course be changed in SSL 360°.

Default Quick Key Assignments:

- 1 - BTA - Back to Arrangement
- 2 - Session/Arrangement Window Toggle
- 3 - Return Tracks - Toggles UF8 faders between controlling standard Audio/MIDI tracks or the Return Tracks.

QUICK

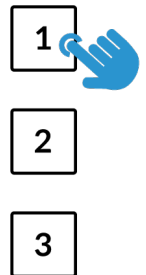

Page Keys

The **PAGE < >** keys allow you to move through the various parameter pages when controlling Devices (Plug-ins) within Live.



Flip

Pressing the **FLIP** key switches the functions of the V-Pots and faders. This is useful for various reasons, including tasks such as controlling Send Levels or Plug-in parameters on the faders instead of the V-Pots.



Send / Plugin 1-8 Keys

The **SEND / PLUGIN 1-8** keys serve no purpose for Live profiles on UF8 and are therefore disabled.

Channel Key

This key serves no purpose for Live profiles on UF8 and is therefore disabled.

V-Pot Assignment Modes

UF8 offers direct access to the Live's main Mackie Control V-Pot assignment modes. These V-Pot assignment modes are accessed via the keys labelled below: 1. **PAN**, 2. **SEND**, 3. **I/O**, 4. **PLUGIN**.

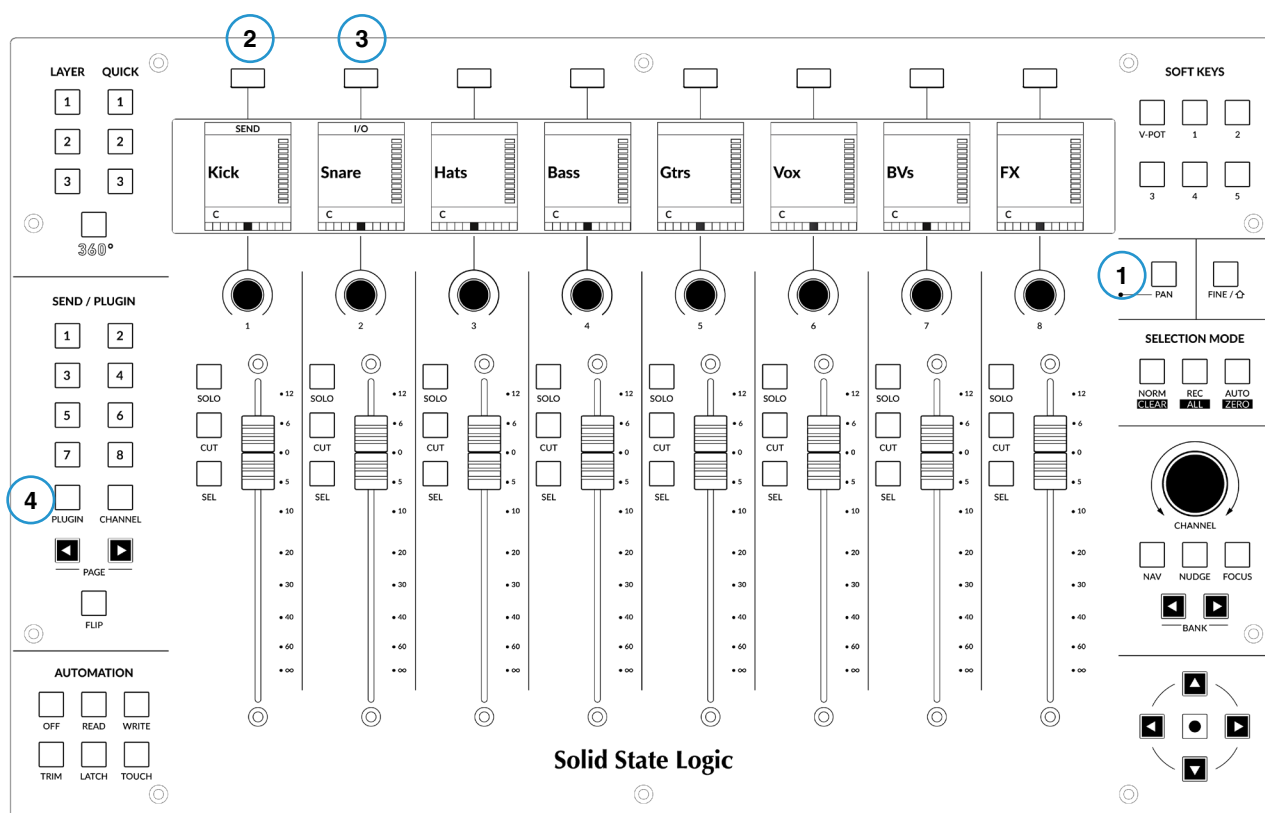

1 - PAN

Assigns the Pan controls to the V-Pots on UF8. Pushing a V-Pot will default it to the centre position.

2 - SEND

Assigns the Send controls for the currently selected track to the V-Pots on UF8. Pushing a V-Pot will default the Send to off.

3 - I/O

Allows you to set the I/O settings for each track on the V-Pots. Pressing the **I/O** key repeatedly will cycle through the following options: Input Type, Input Source, Output Type and Output Destination.

4 - PLUGIN (Devices)

Live's own instruments and also third party audio plug-ins can be controlled directly from UF8. Once you have pressed the **PLUGIN** key to enter this mode, do the following:

- Select the track on which you want to control the plug-in.
- The name(s) of the plug-ins will appear in the LowLCD section of UF8's LCD(s).
- Push the V-Pot of the plug-in you wish to control.
- The parameters of the plug-in will be assigned across the V-Pots. Pushing a V-Pot defaults the parameter. You can also use **FLIP** key to put the plug-in controls onto the faders.
- If there are more than 8 plug-in parameters, you can access them via the **PAGE <>** keys.
- Once you have finished, press the **PLUGIN** key again to return to viewing the names of the plug-ins you have on the currently selected track.

User Bank Pre-Assignments

User Banks 1-5 allow you access to various DAW commands or keyboard shortcuts on the 8 soft keys along the top of UF8. These can of course be changed to any of the available DAW commands or your own keyboard shortcut sequences in the UF8 page of SSL 360°.

SOFT KEYS

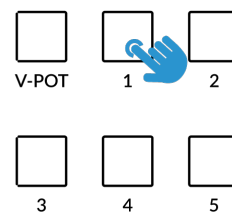

Select User Banks using Keys 1-5 in the **SOFT KEYS** section.

User Bank 1

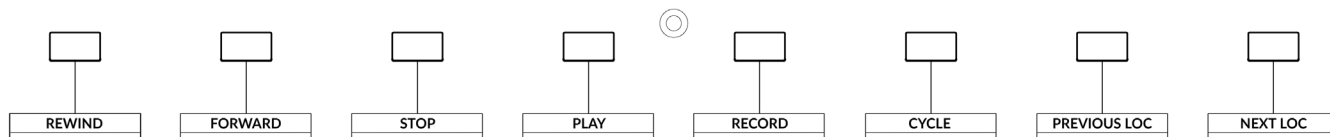

User Bank 2

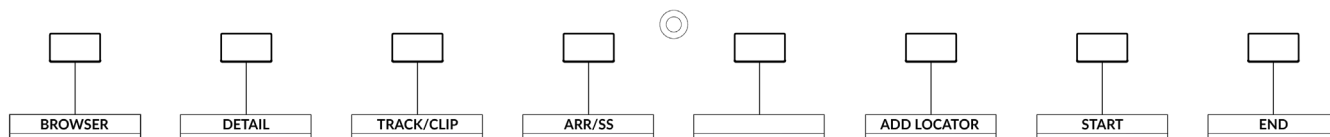

User Bank 3

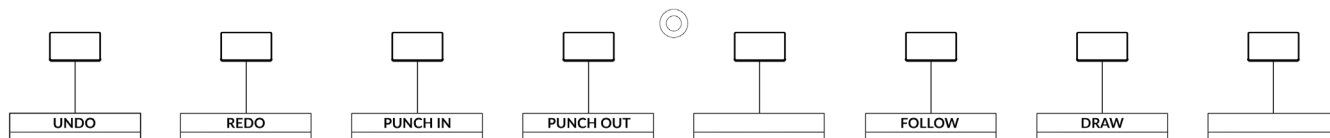

User Bank 4

Unassigned

User Bank 5

Unassigned

Assignable DAW Commands List - Live

The following DAW commands are available in SSL 360° to assign to any of the User or Quick Keys.

I/O
Pan
Page Left
Send
Device
Page Right
Flip
Return Tracks
Shift
Option
Control
Alt
Arr/SS (Arrangement/Session View Toggle)
Track/Clip
Browser
Detail
Undo
BTA (Back To Arrangement)
Draw
Redo
Add Locator
Follow
Previous Loc (Locator)
Next Loc (Locator)
Cycle
Punch In
Punch Out
Start
End
Rewind
Forward
Stop
Play
Record
Launch Clip
Launch Scene

Studio One with UF8 - Tutorial

The following tutorial guides you through configuring and using the default Studio One profile on LAYER 1 of UF8. If you wish to configure Studio One on a different layer, please refer to the DAW Communication section of this User Guide to ensure your DAW is configured for the correct **SSL V-MIDI** ports.

SSL 360° Setup

1. Open the SSL 360° application on your Mac or Windows computer and on the **HOME** page check that any UF8s you have connected are present - outline images of each UF8 appear on screen.
2. If you have multiple UF8s connected, click down on the outline image of each unit to check that the UF8s are arranged in the correct order. If units need to be re-ordered then click and drag to re-arrange.
3. Go to the **UF8** page and set **Layer 1** to **Studio One** using the drop-down list.

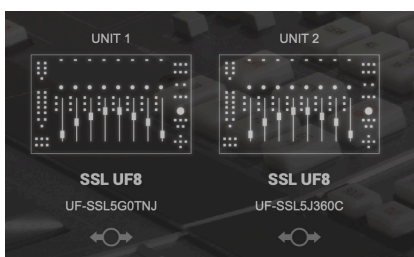

STEP 1 : Open SSL 360° application. Connected UF8s appear on-screen.

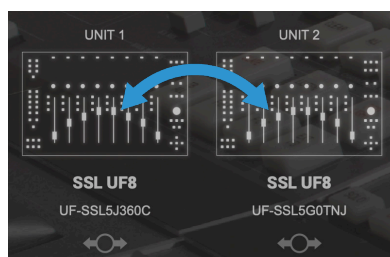

STEP 2 : Click and drag to re-order units if necessary.

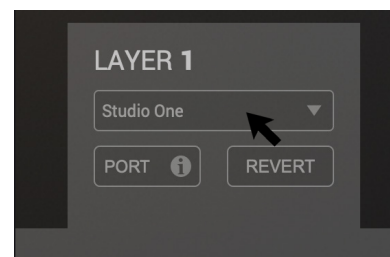

STEP 3 : Select the default Studio One DAW profile from the UF8 page.

Studio One Setup

4. Open Studio One. Go to **Preferences > External Devices** and click on the **Add...** button.
5. In the **Add Device** window, select **Mackie Control** and set **Receive From** to **SSL V-MIDI Port 1 Source** and set **Send To** to **SSL V-MIDI Port 1 Destination**. Click OK.
6. If you have multiple UF8s, go back to the **Add Device** window and select **Mackie Control Extender** for subsequent UF8s, incrementing the **SSL V-MIDI Port** each time - e.g. the second UF8 would be set to **SSL V-MIDI Port 2** for **Receive From** and **Send To**.

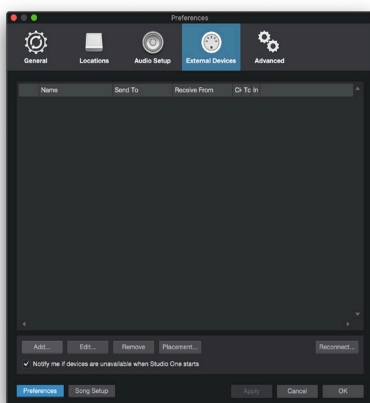

STEP 4 : Go to the Preferences menu and click on the External Devices tab.

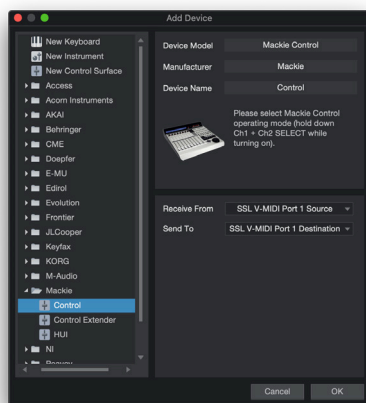

STEP 5 : Add a Mackie Control and configure for SSL V-MIDI Port 1 on Receive From and Send To.

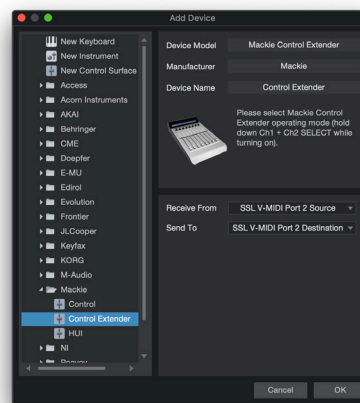

STEP 6 : If you have multiple UF8s, add Mackie Control Extender units and increment SSL V-MIDI Port number each time.

7. As the final step when setting up multiple UF8s, you need to move the Mackie Control and Mackie Control Extender you have configured into what Studio one refers to as a **Control Surface Group**. To do this, click on the **Placement...** button in the **Preferences > External Devices** window and click and drag the Mackie Control and Mackie Control Extender images into **Group 1**.

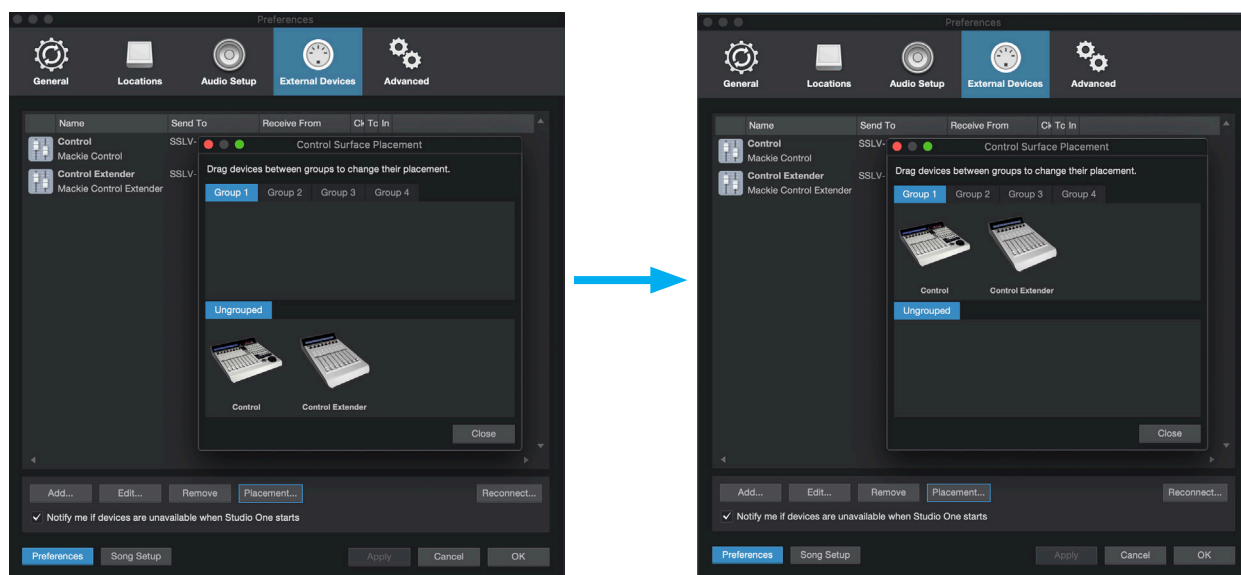

STEP 7 : Go to Control Surface Placement setup and click and drag the Mackie Control and Mackie Control Extender(s) and move them up into Group 1.

LCD Layout

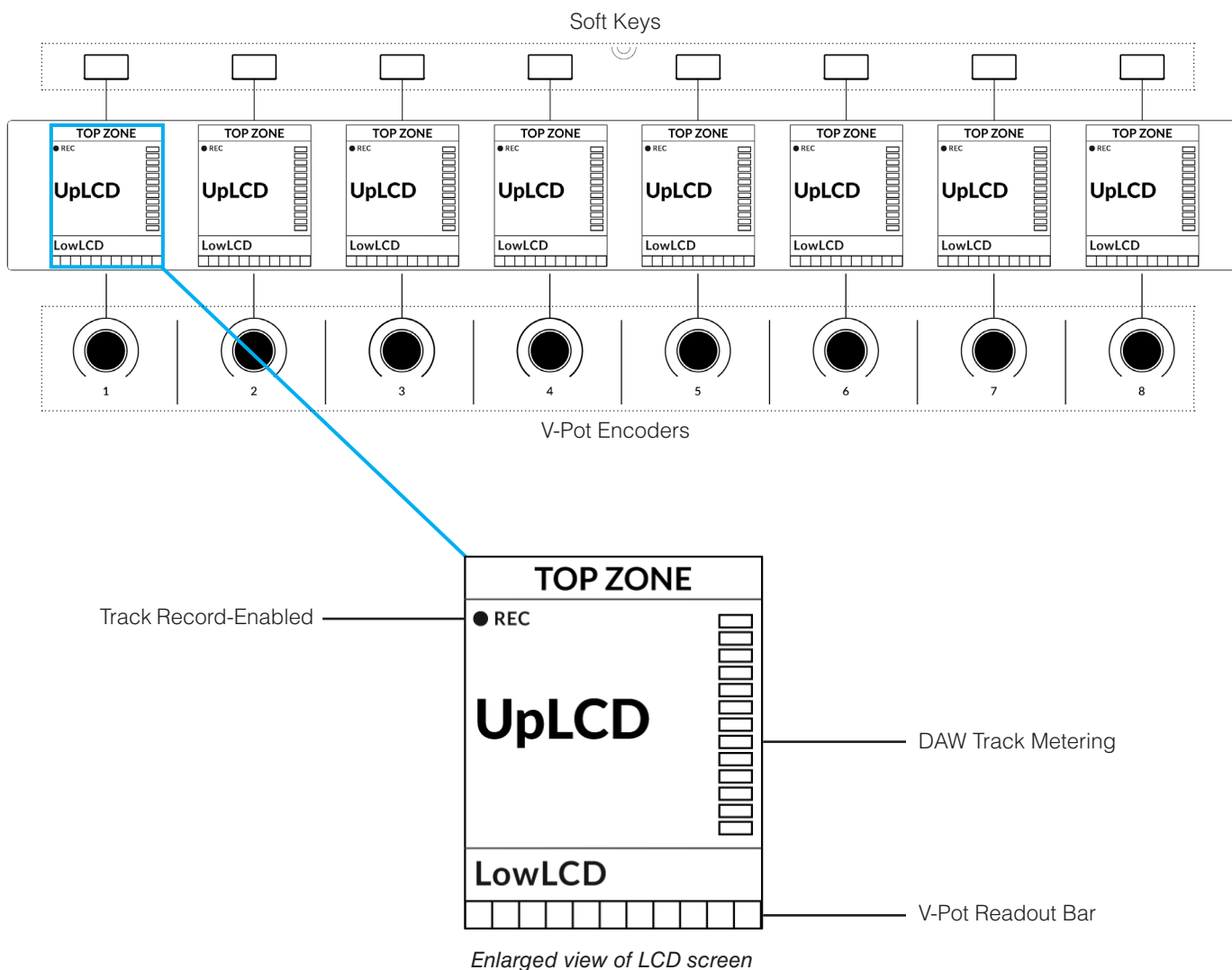

Top Zone - Provides a label for the function assigned to the Soft Key button directly above.

Track Record-Enabled (REC) - In Studio One, the **REC** text appears when a track is record-enabled.

UpLCD - Displays the 6-character track name or parameter being controlled by the V-Pot, depending on the current mode.

LowLCD - Displays a fader value or value readout for the parameter currently assigned to the V-Pot, depending on the current mode.

DAW Track Metering - 12-segment track metering + clip.

V-POT Readout Bar - Displays the position of the currently assigned V-Pot (encoder) function.

Tutorial

This section guides you through using UF8 with Studio One.

Before You Start...

The information in this Studio One Tutorial sets out the key features of using UF8 with Studio One.

Any aspect not covered in this guide can be found in the "**Studio One - Mackie Control Support**" document, available from the Presonus website.

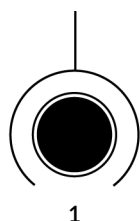

1

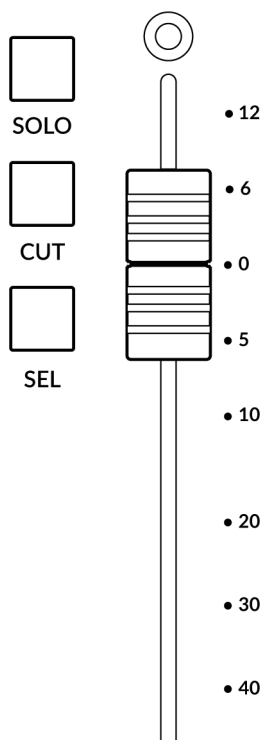

V-Pot

At the top of each strip is the V-Pot (virtual pot). The function of the V-Pot varies, depending on which V-Pot assignment mode is currently active and is typically used for tasks such as controlling Pan position, Pend levels and Plug-in parameters

The V-Pot has a push function, which is typically used for defaulting the position of the parameter being controlled.

100 mm Motorised Fader

Motorised, touch-sensitive faders provide physical control of your Studio One tracks and are great for balancing mix levels and writing automation.

When the V-Pots are controlling Pans, the LowLCD section displays a fader dB readout.

Solo, Cut & Sel (Select)

Each strip contains **SOLO**, **CUT** and **SEL** keys corresponding to the solo, mute and select features for each track in Studio One.

Selection Mode

The primary purpose of the **NORM** and **REC** keys in the **SELECTION MODE** section is to determine the behaviour of the **SEL** keys.

NORM - The **SEL** keys select a track in Studio One.

REC - The **SEL** keys act as record-arm keys.

AUTO - Disabled. This key only applies for Pro Tools profiles.

The secondary labels **CLEAR**, **ALL** and **ZERO** do not apply for Studio One's UF8 integration.

SELECTION MODE



Channel Encoder

By default, the **CHANNEL** encoder is used to move your DAW tracks across the UF8 surface, in increments of 1 channel at a time. If you find yourself in **NAV** or **FOCUS** modes, simply push the **CHANNEL** encoder to return to **CHANNEL** mode.

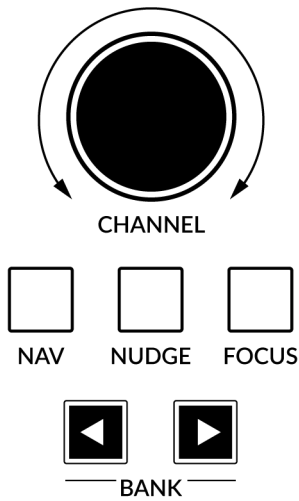

Nav

Pressing the **NAV** key changes the **CHANNEL** encoder to operate the playhead position in Studio One, allowing you to navigate through your session.

Nudge

Disabled. Only applies to Pro Tools profiles.

Focus

Pressing the **FOCUS** key puts the **CHANNEL** encoder into Focus mode, which emulates the scroll function of a mouse. This can be a really nice way of controlling plug-ins or anything else on screen that responds to a mouse scroll operation. Simply open a plug-in GUI, hover your computer mouse over a control and turn the encoder for hands-on control.

The sensitivity of FOCUS mode will vary depending on what plug-in or on-screen element you are controlling. You can use the mouse scroll sensitivity setting in your computer preferences to adjust to taste.

Bank Keys

The **BANK** < > keys allow you to move tracks across your UF8 control surface(s) in multiples of 8, depending on how many UF8s are connected.

Cursor Keys and Mode Key

In the lower-right corner of UF8 are the Cursor keys with the Zoom key in the centre.

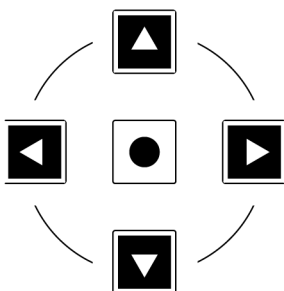

When the Zoom key is lit the left and right cursor keys perform horizontal and vertical track zooming.

Pressing the Zoom key again, the up and down cursor keys change the selected track and the left and right cursor keys change the selected audio clip in the Arrangement View.

Solo Clear (Use the FINE / SHIFT key)



The key on UF8 labelled **FINE / SHIFT** is programmed to execute the Solo Clear function in Studio One.

Automation

You can select the automation mode for each track directly from UF8. To do this, select a track you want to change the automation mode of using a **SEL** key. Then, press the desired automation mode from the **AUTOMATION** keys in the lower-left corner of UF8. The **TRIM** key does not apply for Studio One and is therefore disabled.

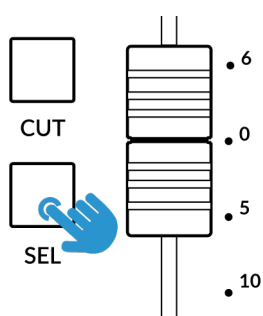

STEP 1: Select a track using SEL key

AUTOMATION

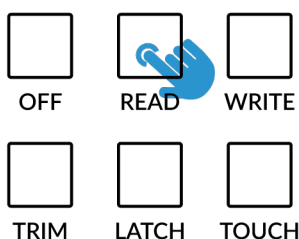

STEP 2: Select the desired automation state.

Quick Keys

The three **QUICK** keys located at the top-left of UF8 are user-assignable keys that are best used for access to your most frequent DAW commands or keyboard shortcuts. By default, they are assigned to the following commands but they can of course be changed in SSL 360°.

Default Quick Key Assignments:

- 1 - Toggles the Console Window on/off
- 2 - Toggles the Inputs View on/off within the Console Window.
- 3 - Open/Closes the Channel Editor Window - used for plug-ins.

QUICK



Page Keys

The **PAGE < >** keys select the previous and next device in an open plug-in editor (Channel Editor Window).



Flip

Pressing the **FLIP** key swaps the functions of the V-Pots and faders. This is useful for various reasons, including tasks such as controlling Send levels or Plug-in parameters on the faders instead of the V-Pots.



V-Pot Assignment Modes

UF8 offers direct access to Studio One's five main Mackie Control V-Pot assignment modes. These V-Pot assignment modes are accessed via the keys labelled below: 1. **PAN**, 2. **SEND**, 3. **INSERT BYPASS**, 4. **TRACK** and 5. **PLUGIN**.

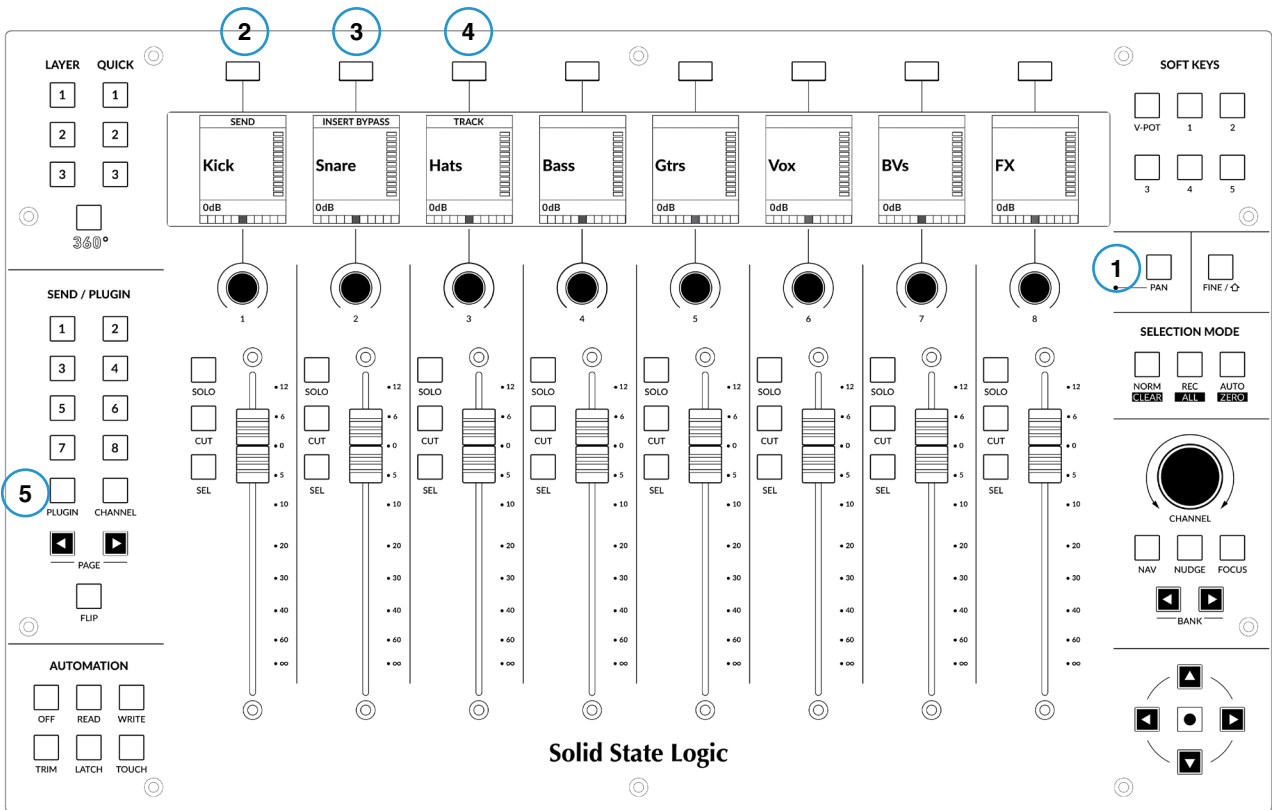

1 - PAN

Assigns the Pan controls to the V-Pots on UF8. Pushing a V-Pot will default the Pan position to centre.

2 - SEND

Assigns the Send controls to the V-Pots. Pushing the V-Pot defaults the Send to 0 dB.

The first press of the **SEND** key will place the Sends of the selected track across the V-Pots and their values will be displayed in the LowLCD zone. The **CHANNEL** key on UF8 will also light.

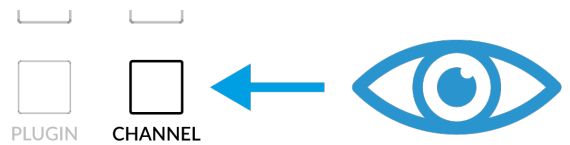

The CHANNEL key lights to let you know the V-Pots are controlling the Sends on the selected track.

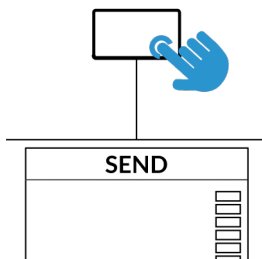

Repeatedly pressing the **SEND** key will cycle the V-Pots through controlling a specific Send 'slot' across all tracks at once. The particular send slot being controlled is reflected by the lighting of the **SEND / PLUGIN** Number Keys 1-8 on the left-hand side.

Repeatedly press the SEND key to cycle the V-Pots into controlling a particular Send slot across all tracks.

As you repeatedly press the SEND key the number of the Send 'slot' the V-Pots are controlling is reflected by UF8 lighting the corresponding number key.

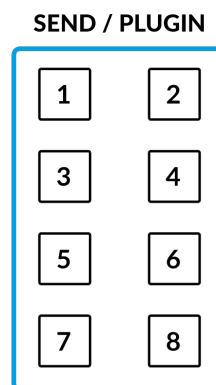

3 - INSERT BYPASS

The V-Pots allow you to Bypass FX Insert Slots for the selected track.

4 - TRACK

The V-Pots allow you to control a number of functions of the selected track:

- V-Pot 1 - Bypass All FX Insert Slots
- V-Pot 2 - Monitor on/off
- V-Pot 3 - Input Source
- V-Pot 4 - Output Source
- V-Pot 5 - Send Slot 1 Bypass
- V-Pot 6 - Send Slot 2 Bypass
- V-Pot 7 - Send Slot 3 Bypass
- V-Pot 8 - Send Slot 4 Bypass

5 - PLUGIN

Sets the V-Pots to 'Control Link' Mode.

In Studio One, you customise which plug-in parameters are controlled on the V-Pots of UF8 for each and every plug-in you want to control. When you press the **PLUGIN** key for the first time, no plug-in parameters will be available because you need to configure whilst in 'Control Link' Mode.

We'll walk through the process on the following pages...

Setting Up Plug-In Control

1. Open up a plug-in you want to configure to be controlled by UF8's V-Pots and click the cog near the top-right.



Click the cog

2. Click the small down arrow near the top-left and make sure 'Recently Touched' is ticked from the drop-down list.



Click the down arrow

Tick 'Recently Touched'

3. Click the small down arrow across to the right and select 'Control' from the drop-down list.



Click the down arrow

Select 'Control'

4. The External Devices Window will appear. Each blue block within the window represents a V-Pot.



Each block represents a V-Pot

5. With your mouse, adjust a plug-in parameter that you want to assign to one of the 8 V-Pots.



Adjust a parameter - in this example, we're moving the LF Gain control

6. Click down on the small hand symbol and drag it across to one of the blocks in the External Devices window.

Click and drag from the small hand symbol into the External Devices window



7. The control has been successfully assigned to the first V-Pot. Repeat the process with other parameters and other plug-ins as you desire.



Successfully assigned control to V-Pot 1

User Bank Pre-Assignments

User Banks 1-5 allow you access to various DAW commands or keyboard shortcuts on the 8 soft keys along the top of UF8. These can of course be changed to any of the available DAW commands or your own keyboard shortcut sequences in the UF8 page of SSL 360°.

SOFT KEYS

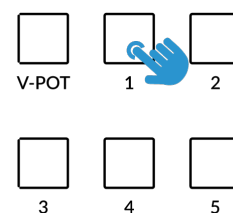

Select User Banks using Keys **1-5** in the **SOFT KEYS** section.

User Bank 1

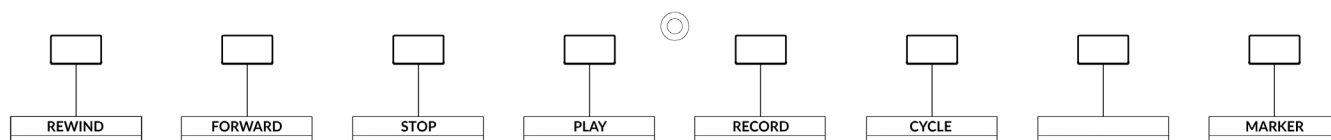

User Bank 2

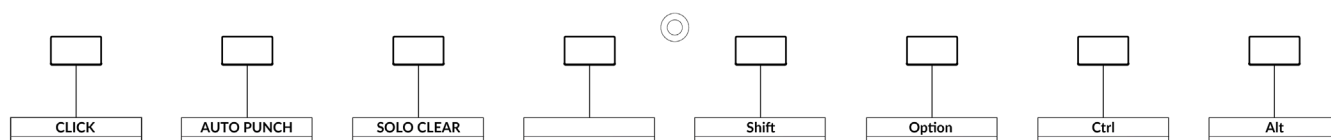

User Bank 3

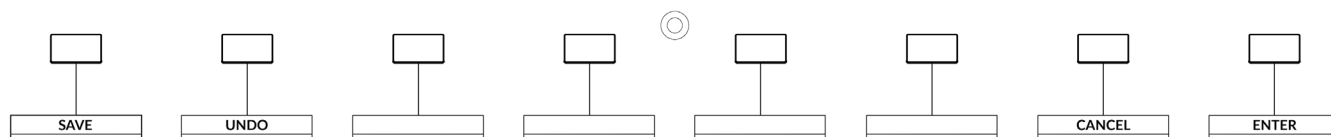

User Bank 4

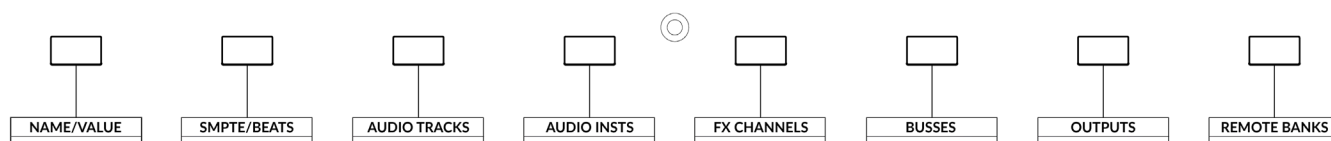

User Bank 5 (F1-F8 Function keys)

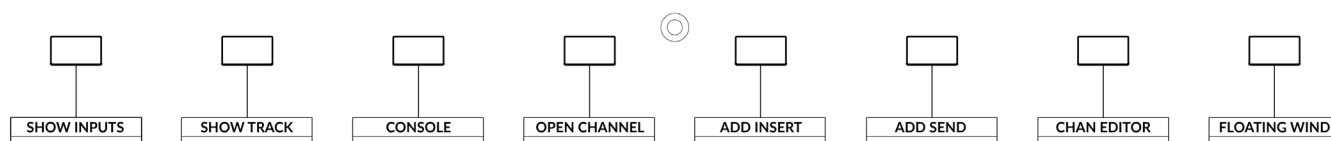

Function Select Keys 1-8 (F1 - F8)

User Bank 5 is pre-assigned to F keys 1-8. The functions of the F keys can be changed in Studio One in the External Devices window (the same window used to assign plug-in parameters to V-Pots). If you have changed an F key away from its default assignment, you can of course re-label the key in SSL 360° using the Short Label text entry box, so the correct function names show on UF8's LCDs.

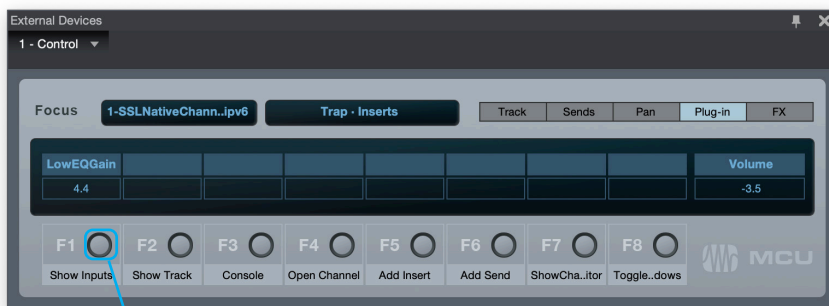

Right-click on the button and click 'Assign Command...' to change the function of any of the F keys.

Assignable DAW Commands List - Studio One

The following DAW commands are available in SSL 360° to assign to any of the User or Quick Keys. Labels in brackets are added to clarify what a command does when it may not be obvious according to the original Mackie Control label.

Track	Play Foot-switch
Pan Sur	Record Foot-switch
EQ (Insert Bypass)	
Send	
Plugin	
Flip	
Global View	
Name/Value	
SMPTE/Beats	
F1 (Show Inputs)	
F2 (Show Track)	
F3 (Console)	
F4 (Open Channel)	
F5 (Add Insert)	
F6 (Add Send)	
F7 (Show Channel Editor)	
F8 (Toggle Floating Window)	
Audio Tracks	
Audio Instruments	
Aux (FX Channels)	
Busses	
Outputs	
User (Remote Banks)	
Shift	
Option	
Control	
Alt	
Read/Off	
Write	
Touch	
Latch	
Save	
Undo	
Cancel	
Enter	
Marker	
Cycle	
Drop (Auto Punch)	
Click	
Solo (Clear)	
Forward	
Rewind	
Stop	
Play	
Record	

Plug-in Mixer - Tutorial

The following tutorial guides you through configuring and using the Plug-in Mixer profile on UF8.

SSL 360° Setup

1. Open the SSL 360° application on your Mac or Windows computer and on the **HOME** page check that any UF8s you have connected are present - outline images of each UF8 appear on screen.
2. If you have multiple UF8s connected, click down on the outline image of each unit to check that the UF8s are arranged in the correct order. If units need to be re-ordered then click and drag to re-arrange.
3. Go to the **UF8** page and set a Layer to **Plug-in Mixer** using the drop-down list.

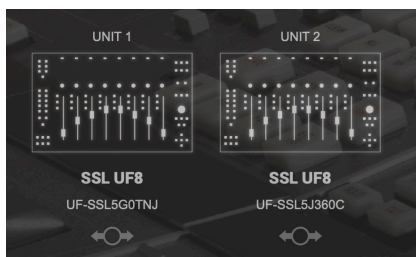

STEP 1 : Open SSL 360° application. Connected UF8s appear on-screen.

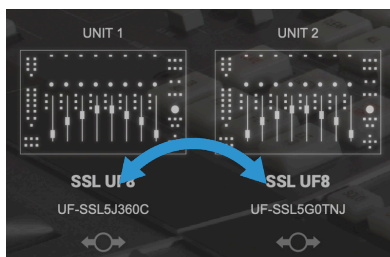

STEP 2 : Click and drag to re-order units if necessary.

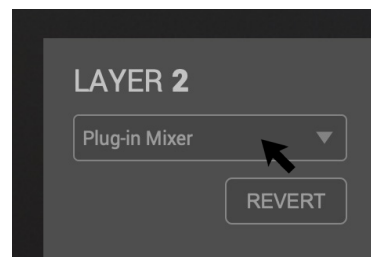

STEP 3 : Select the Plug-in Mixer profile from the UF8 page.

You need to be on SSL 360° v1.2 or above to set a Layer to Plug-in Mixer.

Plug-in Mixer Setup

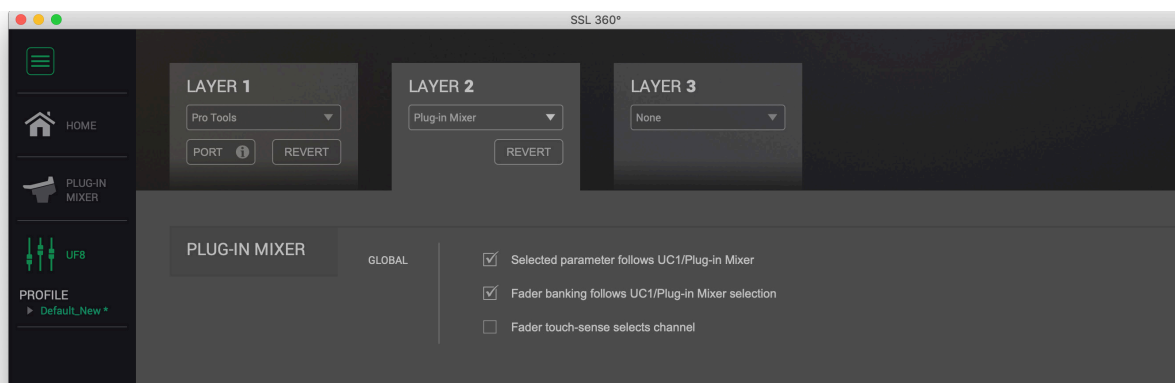

Selected parameter follows UC1/Plug-in Mixer - With this mode enabled, the Channel Strip or Bus Compressor parameter assigned across the V-Pots will automatically change in response to the parameter being moved/actioned in the Plug-in Mixer, on UC1 or in the Plug-in itself. e.g. if you move the LMF Frequency control in any of these places, UF8's V-Pots will automatically switch to control that parameter.

Fader banking follows UC1/Plug-in Mixer selection - With this mode enabled, the bank of faders UF8(s) is focused on will automatically move to include the Channel Strip plug-in that is being selected in the Plug-in Mixer or that is being opened in the DAW, if it is not already visible on the UF8 surface.

Fader touch-sense selects channel - With this mode enabled, touching a fader will select it in the Plug-in Mixer.

Tutorial

This section guides you through using UF8 with the Plug-in Mixer.

Before You Start...

The concept behind the control of the Plug-in Mixer from UF8 is focused on extending the functionality of the UC1 controller, by allowing you to access multiple channels of the Plug-in Mixer at once.

As such, all V-Pots are assigned **to the same selected parameter**, like looking across a mixing desk with a consistent layout of controls horizontally.

Accessing Channel Strip Mode, Bus Compressor Mode, Metering

Unlike the DAW profiles, the three **QUICK** keys located at the top-left of UF8 are not user-definable when UF8 is set to control the Plug-in Mixer. Instead they always perform the following functions:

Default Quick Key Assignments:

- 1 - Channel Strip Mode - UF8 controls Channel Strips in the Plug-in Mixer
- 2 - Bus Compressor Mode - UF8 controls Channel Strips in the Plug-in Mixer
- 3 - Toggles Channel Strip metering on UF8 between Input and Output metering.

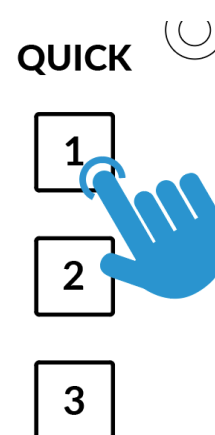

LCD Layout - Channel Strip Mode

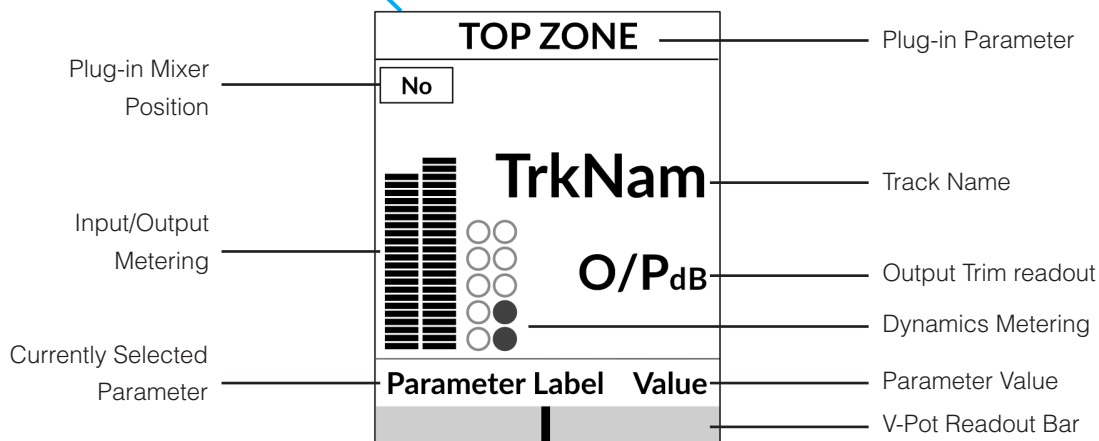
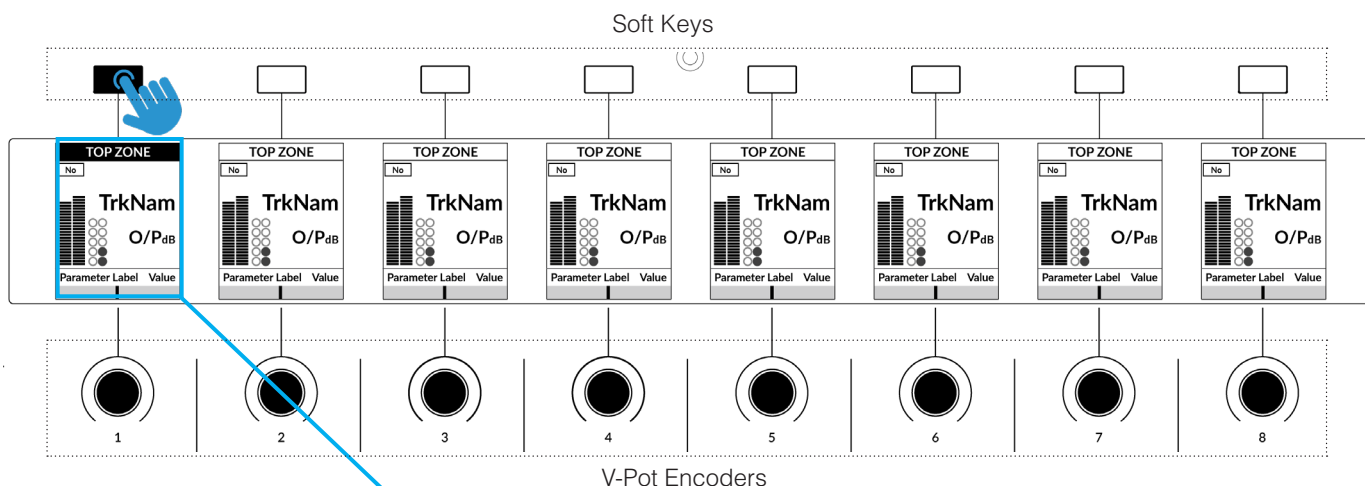

Enlarged view of LCD screen

Top Zone - Provides a label for the function assigned to the Soft Key button directly above. In the case of the Plug-in Mixer, these Soft Keys are used to select the Channel Strip plug-in parameter that gets assigned to the V-Pots.

Plug-in Mixer Position - Displays the position of the Channel Strip plug-in in the Plug-in Mixer.

TrkNam - Displays the DAW track name that the plug-in is inserted on in the DAW.

O/PdB - Displays the Channel Strip Output Trim value of the plug-in.

Input/Output Metering - Displays the input or output metering of the plug-in. Can be toggled with **Quick Key 3**.

Dynamics Metering - Displays the gate and compressor gain reduction activity from the plug-in.

Currently Selected Parameter across the V-Pots - Displays the name of the Channel Strip parameter currently assigned across the V-Pots.

Value - Displays the value of the currently assigned plug-in parameter on that instance of Channel Strip.

V-Pot Readout Bar - Displays the position of the currently assigned V-Pot (encoder) parameter.

LCD Layout - Bus Compressor Mode

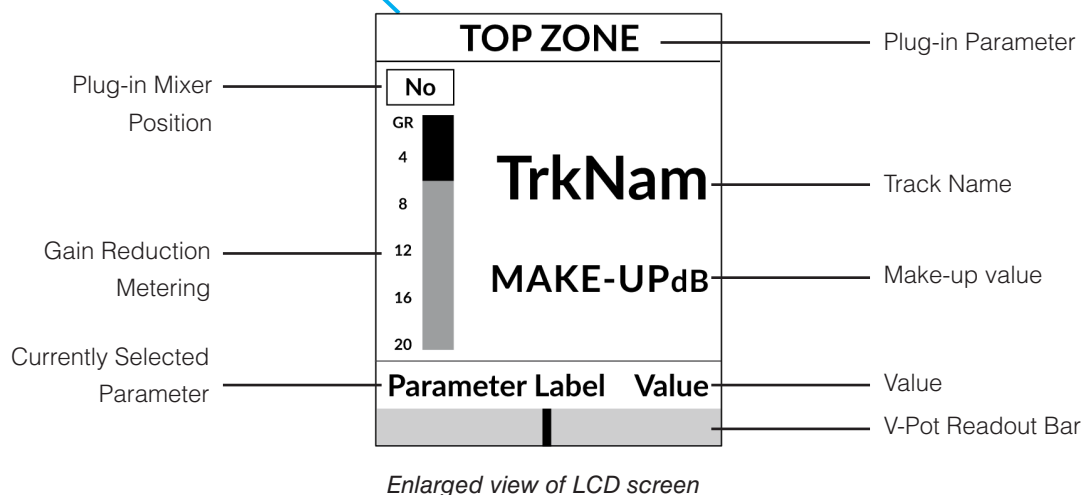
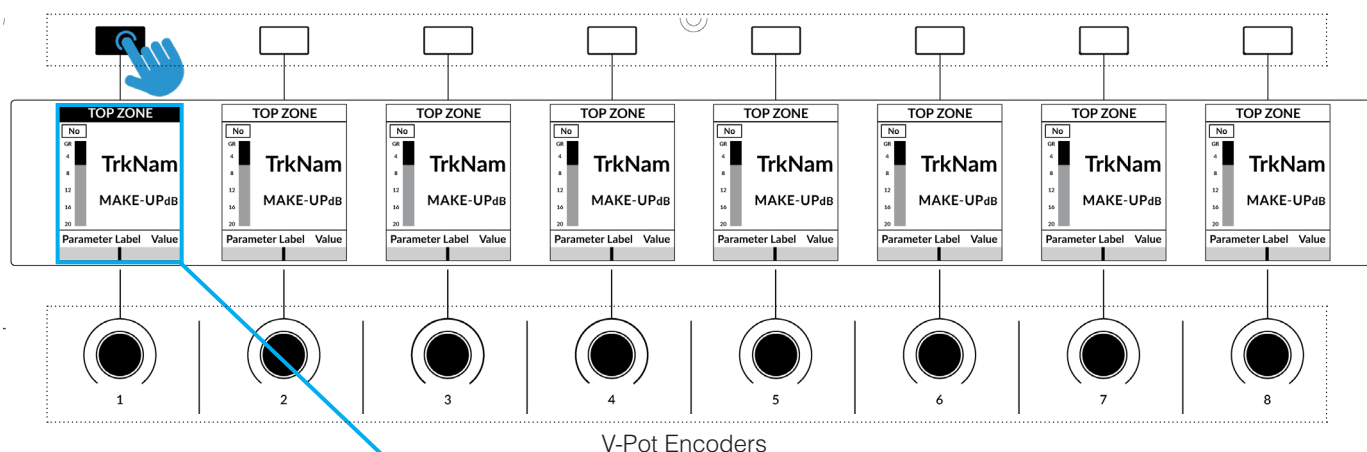

Top Zone - Provides a label for the function assigned to the Soft Key button directly above. In the case of the Plug-in Mixer, these Soft Keys are used to select the Bus Compressor plug-in parameter that gets assigned to the V-Pots.

Plug-in Mixer Position - Displays the slot number to which the Bus Compressor plug-in is assigned to in the Plug-in Mixer.

TrkNam - Displays the DAW track name that the plug-in is inserted on in the DAW.

MAKE-UPdB - A readout of the Bus Compressor **MAKE-UP** Gain parameter.

Gain Reduction Metering - Displays the amount of gain reduction being applied by the Bus Compressor plug-in.

Currently Selected Parameter across the V-Pots - Displays the name of the Bus Compressor parameter currently assigned across the V-Pots.

Value - Displays the value of the currently assigned plug-in parameter on that instance of the Bus Compressor.

V-Pot Readout Bar - Displays the position of the currently assigned V-Pot (encoder) parameter.

V-Pots and Fader

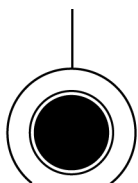

1

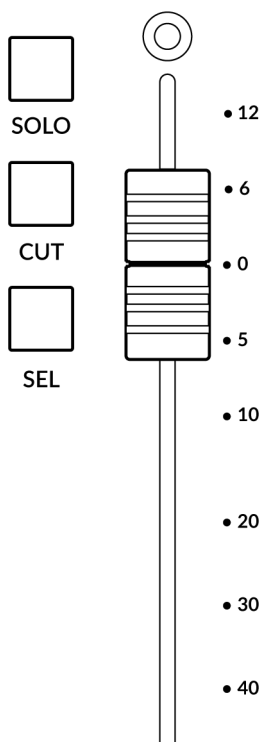

V-Pot

At the top of each strip is the V-Pot (virtual pot). The function of the V-Pot varies, depending on which V-Pot assignment mode is currently active.

The V-Pot has a push function, which is used for defaulting the position of the parameter being controlled.

100 mm Motorised Fader

By default the faders are assigned to the **OUTPUT TRIM** Gain in Channel Strip Mode or the **MAKE-UP** Gain in Bus Compressor mode. However, any parameter that is assigned to the V-Pots with continuous control (i.e. not switch functions) can be flipped onto the fader with the **FLIP** key.

Solo, Cut & Sel (Select)

Each strip contains **SOLO**, **CUT** and **SEL** keys.

In Channel Strip Mode, the **SOLO** and **CUT** keys control Solo and Cut buttons in the Channel Strip plug-in, whilst **SEL** key selects the Channel Strip in the Plug-in Mixer.

In Bus Compressor Mode, the **SEL** key selects the Bus Compressor in the Plug-in Mixer.

Selection Mode

The primary purpose of the **NORM** and **REC** keys in the **SELECTION MODE** section is to determine the behaviour of the **SEL** keys.

NORM - The **SEL** keys function as select keys in the Plug-in Mixer

REC - N/A

AUTO - N/A

SELECTION MODE

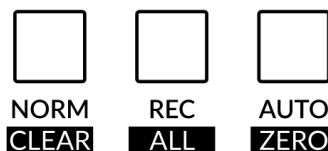

The secondary labels **CLEAR** and **ZERO** refer to the push and hold functions available.

CLEAR SOLOS/MUTES - Press and hold the **CLEAR** key and press any active **SOLO** key to clear all Channel Strip Solos. Press and hold the **CLEAR** key and press any active **CUT** to clear any Channel Strip Cuts.

DEFAULT PARAMETER ASSIGNED TO THE FADER - Press and hold the **ZERO** key and press any **SEL** key to default the parameter that is being controlled across the faders on that track.

Channel Encoder

By default, the **CHANNEL** encoder is used to move your Channel Strips across the UF8 surface, banking in increments of 1 channel at a time.

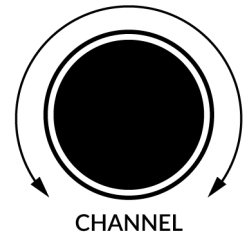

Bank Keys

The **BANK < >** keys allow you to move Channel Strips across your UF8 control surface(s) in multiples of 8, depending on how many UF8s are connected.

Page Keys

The Page keys provide an alternative way of changing the selected **SOFT KEY** bank.

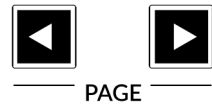

FINE Key

When **FINE** is held, the gearing of the V-Pots is altered to allow for a finer resolution of whatever parameter is currently assigned to them.



FLIP Key

Pressing the **FLIP** key duplicates the controls that are currently assigned to the V-Pots onto the faders.



V-Pot Assignments

All the parameters of the Channel Strip and Bus Compressor plug-ins that are assignable to the V-Pots, can be selected using the Soft Keys along the top of UF8.

Use the **SOFT KEY** bank buttons (**V-POT, 1, 2, 3, 4** and **5**) to locate the bank that contains the parameter you want to control on the V-Pots and then press the corresponding soft key to assign it to the V-Pots.

Remember, if you have **Selected parameter follows UC1/Plug-in Mixer**, the Channel Strip or Bus Compressor parameter assigned across the V-Pots will still change automatically in response to the parameter being moved/actioned in the Plug-in Mixer, on UC1 or in the Plug-in itself.

SOFT KEYS

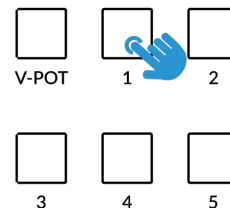

The parameters are spread across the SOFT KEY banks

SOFT KEY Bank Assignments - Channel Strip Mode

V-POT Bank

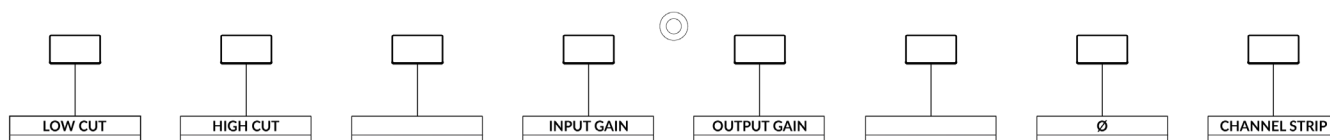

Bank 1

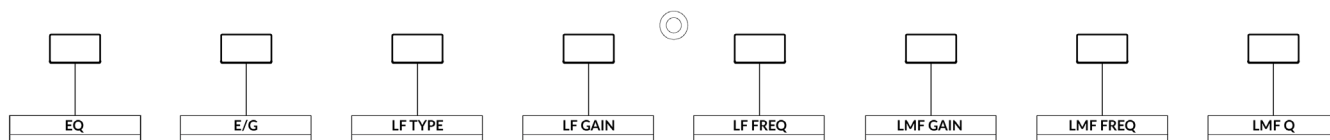

Bank 2

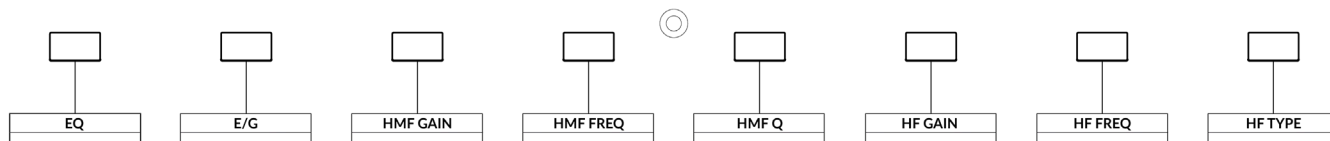

Bank 3

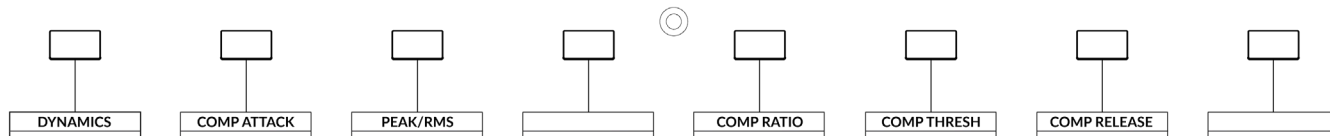

Bank 4

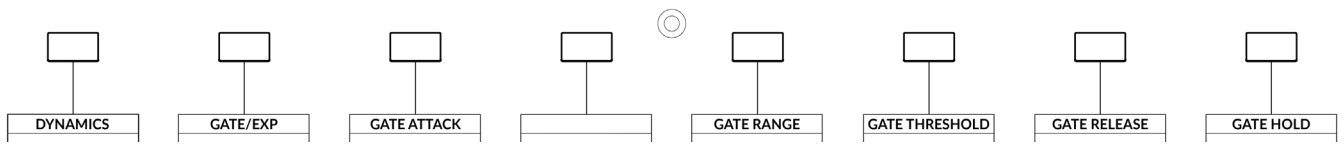

Bank 5

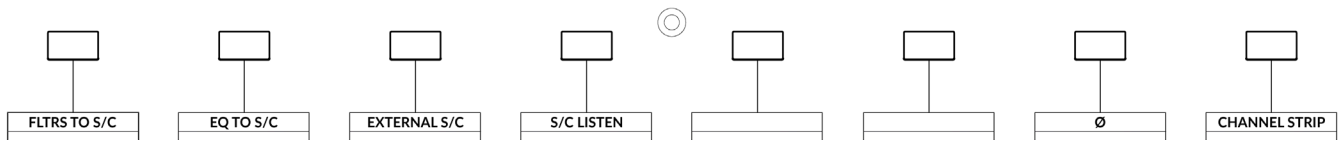

SOFT KEY Bank Assignments - Bus Compressor Mode

V-POT Bank

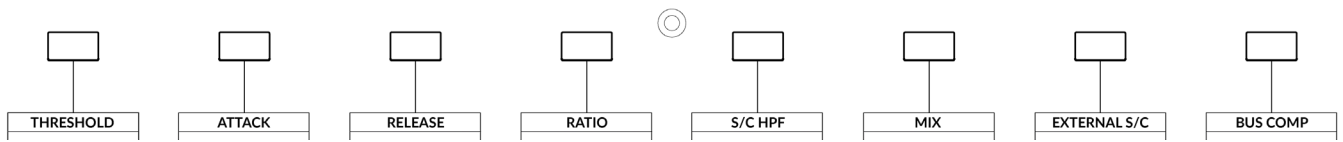

Bank 1

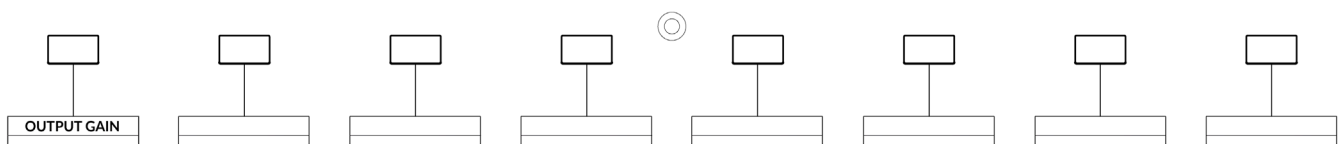

UF8 LCD Messages

The LCDs of UF8 show certain information, depending on UF8's status.

Booting / UF8 Identify



This message is displayed when you power up UF8, accompanying the 'fader wave'.

You also see this state when you're clicking to identify UF8s from the **HOME** page of the SSL 360° software.

'Awaiting Connection to SSL 360° Software'

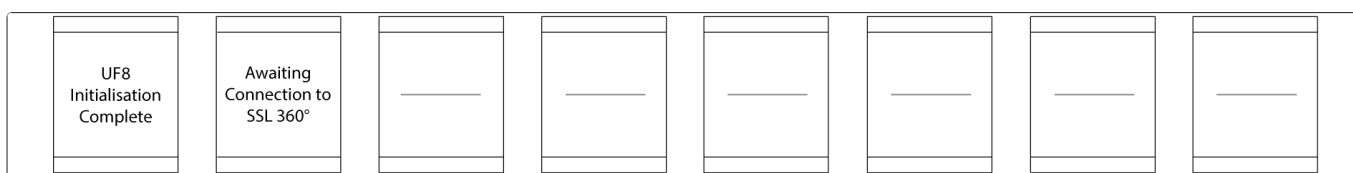

'UF8 Initialisation Complete' means that the UF8 hardware boot sequence has completed. 'Awaiting Connection to SSL 360°' means that UF8 is waiting for the SSL 360° software to start running on the computer. You may see this message appear when logging onto your computer, before the operating system has finished loading your user-profile and start-up items. You may also see this message if you are yet to plug a USB cable from your UF8 into your computer.

'Layer Set To None'

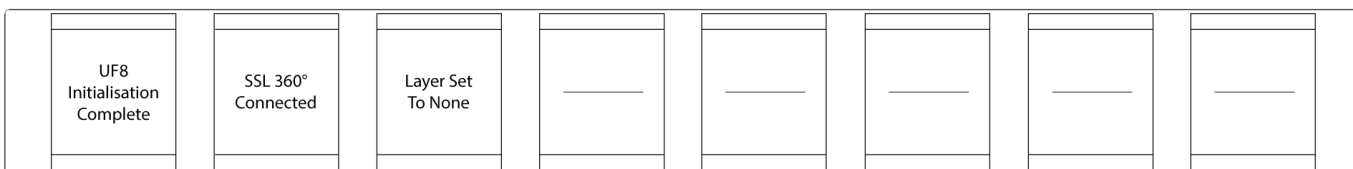

If you see this message, you have not yet chosen a DAW profile for the UF8 Layer. Head to the UF8 page and select the DAW you are using from the drop-down list.

'Waiting For DAW' (Pro Tools only)

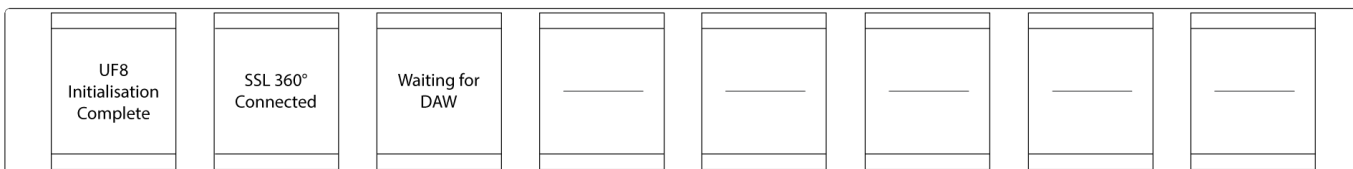

If you have configured a Layer for Pro Tools but Pro Tools is closed or you have yet to configure UF8 as a MIDI controller in Pro Tools, then you will see this message.

'SSL 360° Connection Lost. Attempting to Reconnect'

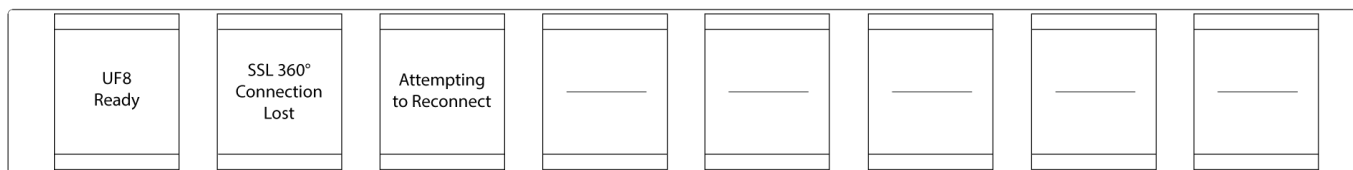

The LCD message above means that communication between SSL 360° and UF8 has been lost. If you experience this, then check that your USB cable connecting UF8 and 360° has not been removed. Re-connect if so.

SSL 360° Software Messages

If the **HOME** page of SSL 360° is displaying the message '**NO DEVICES CONNECTED**', then be sure to check that the USB cable from your computer to the **USB** port on UF8 has not come loose.

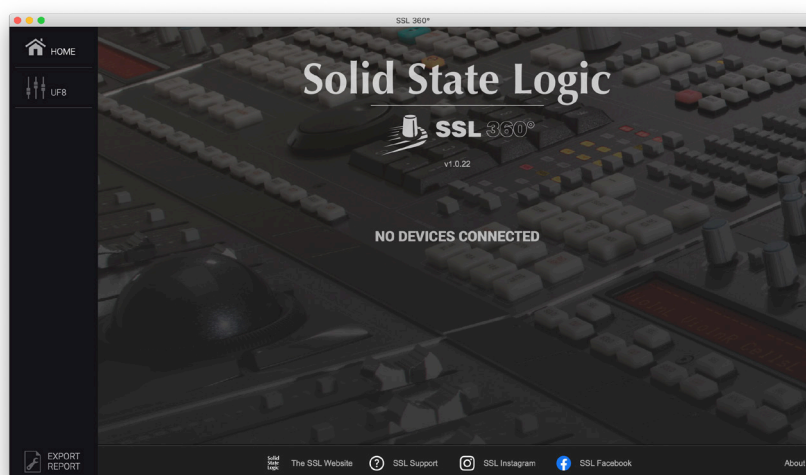

If the **HOME** page of SSL 360° is displaying the message '**SOMETHING WENT WRONG... PLEASE EXIT AND RE-LAUNCH SSL 360°**', then please quit SSL 360° and re-launch. If that does not work then restart your computer.

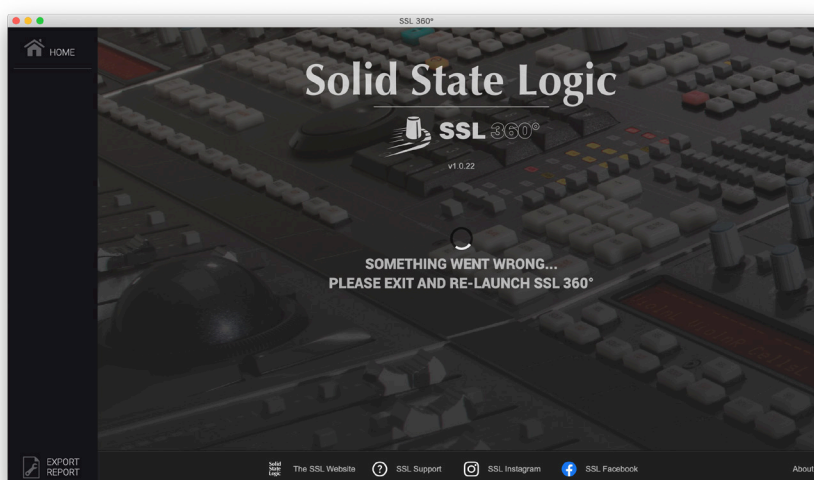

SSL Support - FAQs, Ask a Question and Compatibility

Visit the Solid State Logic Help Centre to check compatibility with your system and find answers to your questions:

www.solidstatellogic.com/support

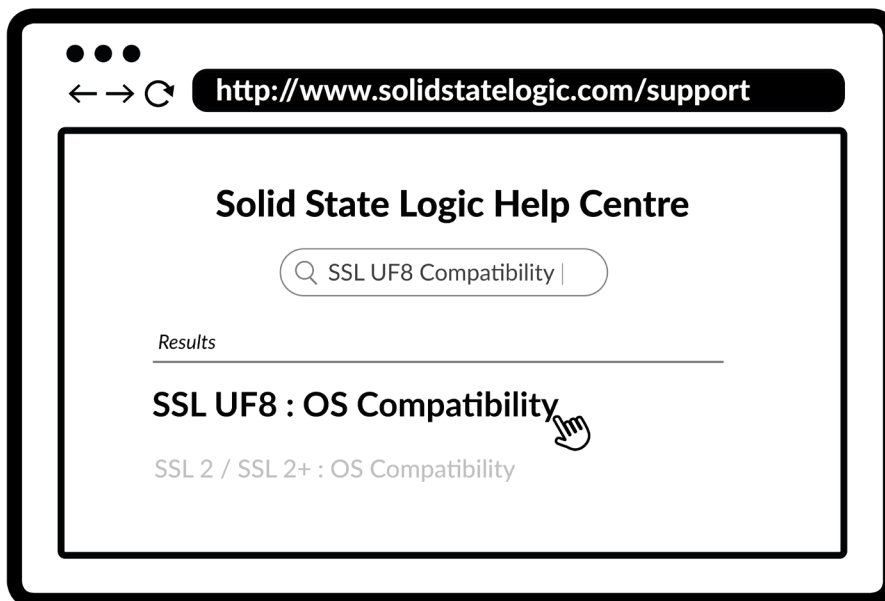

Thank you

Don't forget to register your UF8 for the best possible experience.

www.solidstatellogic.com/get-started

Safety Notices

General Safety

- Read these instructions.
- Keep these instructions.
- Heed all warnings.
- Follow all instructions.
- Do not use this apparatus near water.
- Clean only with dry cloth.
- Do not block any ventilation openings. Install in accordance with the manufacturer's instructions.
- Do not install near any heat sources such as radiators, heat registers, stoves or other apparatus (including amplifiers) that produce heat.
- Do not defeat the safety purpose of the polarized or grounding-type plug. A polarized plug has two blades with one wider than the other. A grounding type plug has two blades and a third grounding prong. The wide blade or the third prong are provided for your safety. If the provided plug does not fit into your outlet, consult an electrician for replacement of an obsolete outlet.
- Protect the adapter and power cord from being walked on or pinched particularly at plugs, convenience receptacles, and the point where they exit from the apparatus.
- Only use the attachments/accessories recommended by the manufacturer.
- Unplug this apparatus during lightning storms or when unused for long periods of time.
- Refer all servicing to qualified service personnel. Servicing is required when the apparatus has been damaged in any way, such as power-supply cord or plug is damaged, liquid has been spilled or objects have fallen into the apparatus, the apparatus has been exposed to rain or moisture, does not operate normally, or has been dropped.
- Do NOT modify this unit, alterations may affect performance, safety and/or international compliance standards.
- SSL does not accept liability for damaged caused by maintenance, repair or modification by unauthorised personnel.

Installation Notes

- When using this apparatus place it on a secure level surface.
- Always allow free flow of air around the unit for cooling. We recommend the use of rackmount kit available from SSL.
- Ensure that no strain is placed on any cables connected to this apparatus. Ensure that all such cables are not placed where they can be stepped on, pulled or tripped over.

WARNING: To reduce the risk of fire or electric shock do not expose this apparatus to rain or moisture.

ATTENTION: Afin de réduire les risques de choc électrique, ne pas exposer cet appareil à l'humidité ou à la pluie.

Power Safety

- UF8 is supplied with an external 12 V DC desktop power supply with a 5.5 mm plug to connect to the unit. A standard IEC mains lead is provided to power the DC supply however if you decide to use a mains cable of your choice, bear in mind the following:
 - 1) The adapter power cord should ALWAYS be earthed with the earth on the IEC socket.
 - 2) Please use-compliant 60320 C13 TYPE SOCKET. When connecting to supply outlets ensure that appropriate sized conductors and plugs are used to suit local electrical requirements.
 - 3) Maximum cord length should be 4.5 m (15').
 - 4) The cord should bear the approval mark of the country in which it is to be used.
- Connect only to an AC power source that contains a protective earthing (PE) conductor.
- Only connect units to single phase supplies with the neutral conductor at earth potential.
- Both the mains plug and appliance coupler can be used as the disconnect device, ensure that the mains plug is connected to an unobstructed wall outlet and is permanently operable.

General Safety



ATTENTION! The desktop power supply must always be earthed. Refer to the User Guide for further details.



CAUTION! No user-serviceable parts inside. In the event of damage to the unit or power supply contact Solid State Logic. Service or repair must be done by qualified service personnel only.

CE Certification



UF8 is CE compliant. Note that any cables supplied with SSL equipment may be fitted with ferrite rings at each end. This is to comply with the current regulations and these ferrites should not be removed.

FCC Certification

- Do not modify this unit! The product, when installed as indicated in the instructions contained in the installation manual, meets FCC requirements.
- Important: This product satisfies FCC regulations when high quality shielded cables are used to connect with other equipment. Failure to use high quality shielded cables or to follow the installation instructions may cause magnetic interference with appliances such as radios and televisions and will void your FCC authorisation to use this product in the USA.
- This equipment has been tested and found to comply with the limits for a Class B digital device, pursuant to part 15 of the FCC Rules. These limits are designed to provide reasonable protection against harmful interference in a residential installation. This equipment generates, uses and can radiate radio frequency energy and, if not installed and used in accordance with the instructions, may cause harmful interference to radio communications. However, there is no guarantee that interference will not occur in a particular installation. If this equipment does cause harmful interference to radio or television reception, which can be determined by turning the equipment off and on, the user is encourage to try to correct the interference by one or more of the following measures:
 - 1) Reorient or relocate the receiving antenna.
 - 2) Increase the separation between the equipment and receiver.
 - 3) Connect the equipment into an outlet on a circuit different from that to which the receiver is connected.
 - 4) Consult the dealer or an experienced radio/TV technician for help.

Industry Canada Compliance

This Class B digital apparatus complies with Canadian ICES - 003.

RoHS Notice

Solid State Logic complies with and this product conforms to European Union's Directive 2011/65/EU on Restrictions of Hazardous Substances (RoHS) as well as the following sections of California law which refer to RoHS, namely sections 25214.10, 25214.10.2, and 58012, Health and Safety Code; Section 42475.2, Public Resources Code.



Instructions for disposal of WEEE by users in the European Union

The symbol shown here, which is on the product or on its packaging, indicates that this product must not be disposed of with other waste. Instead, it is the user's responsibility to dispose of their waste equipment by handing it over to a designated collection point for recycling of waste electrical and electronic equipment. The separate collection and recycling of your waste equipment at the time of disposal will help to conserve natural resources and ensure that is recycled in a manner that protects human health and the environment. For more information about where you can drop off your waste equipment for recycling, please contact your local city office, your household waste disposal service or where you purchased the product.



WARNING: Cancer and Reproductive Harm - www.P65Warnings.ca.gov



Evaluation of apparatus based on altitude not exceeding 2000 m. There may be some potential safety hazard if the apparatus is operated at altitude exceeding 2000 m.



Evaluation of apparatus based on temperate climate conditions only. There may be some potential safety hazard if the apparatus is operated in tropical climate conditions.

Electromagnetic Compatibility

EN 55032:2015, Environment: Class B, EN 55103-2:2009, Environments: E2 - E4.

Electrical Safety: UL/IEC 62368-1:2014.

WARNING: Operation of this equipment in a residential environment could causes radio interference.

Environmental

Temperature: Operating: +1 to 30 degrees Celsius. Storage: -20 to 50 degrees Celsius.

Further information

For additional information, install and user guides, knowledge base and technical support visit www.solidstatelogic.com

